



2026

The Equal Chance to Win

OFFSHORE RACING CONGRESS



2026 - Sorrento, Italy - ORC Worlds © Studio Borlenghi

ORC VPP Documentation 2026

Copyright © 2026 Offshore Racing Congress

All rights reserved. Reproduction in whole or in part is only with the permission of the Offshore Racing Congress.

CONTENTS

1	Background	10
2	Introduction	11
2.1	Scope	11
2.2	Overview	11
2.3	Layout	11
3	VPP Methodology	12
3.1	Solution Method	12
3.2	Boat Model	13
3.2.1	Functional relationships	14
3.3	Equations of Equilibrium	16
3.3.1	Driving Force - Drag	16
3.3.2	Heeling Moment - Rolling Moment	17
3.4	Water Ballast and Canting Keel Yachts	18
3.4.1	Canting Keel	18
3.4.2	Daggerboard (Centreline lifting appendage)	18
3.4.3	Daggerboard and Bilge boards	18
3.4.4	Water ballast	19
3.4.5	Measurement	19
3.5	Foiling yachts	19
3.5.1	Foils Geometry and Modelling	19
3.5.2	Semifoiling	20
3.5.3	Full foiling	21
3.6	Dynamic Allowance (DA)	22
3.6.1	Credits (2012)	22
3.6.2	Calculation Procedure	23
3.7	Non Manual Power	23
4	Lines Processing Program	24
4.1	Hydrostatics	24
4.2	LPP Output parameter definitions	25
4.2.1	Measurement Trim	25
4.2.2	Sailing Trim	25
4.2.3	Second Moment Length (LSM)	26
4.2.4	Appendage stripping	27
4.2.5	Beam Depth Ratio (BTR)	27
4.2.6	Maximum Effective Draft (MHSD)	28
4.2.7	Bulb/Wing Effects	29
4.3	Appendage wetted areas and lengths	32
4.3.1	Conventional Fin keel and rudder	32
4.3.2	Other appendages	32
4.4	Righting Moment	33
4.4.1	Righting Arm Curve	33
4.4.2	Hydrodynamic Centre of Pressure	33
4.4.3	Crew righting moment	33
4.4.4	Dynamic Righting Moment. RMV	35
4.4.5	Rated Righting Moment	35

5	Aerodynamic Forces	37
5.1	Methodology	37
5.1.1	Individual Sail Areas and 2-Dimensional Aerodynamic Force Coefficients	37
5.1.2	Simplified Rigging Coefficients	38
5.1.3	Optimization and De-powering	39
5.2	Sail Areas & Coefficients	41
5.2.1	Mainsail	41
5.2.2	Jib or Genoa	45
5.2.3	Spinnakers	47
5.2.4	Spinnaker tack position <i>Power</i> Function	50
5.2.5	Headsails set flying	51
5.3	Windage Forces	53
5.3.1	Rigging	54
5.4	Total Aerodynamic Lift and Drag	54
5.4.1	Lift and Drag of complete sail set	55
5.4.2	Center of Effort Height	55
5.4.3	Induced Drag	56
5.5	Resolution of Forces	58
5.5.1	Thrust and Heeling Force	58
5.5.2	Aerodynamic heeling Moment	59
5.6	Blanketing functions	59
5.6.1	Mainsail	59
5.6.2	Jib	59
5.6.3	Mizzen, Jib Downwind, Spinnaker	59
5.6.4	Mizzen Staysail	59
6	Hydrodynamic Forces	60
6.1	Viscous Resistance	60
6.1.1	Canoe body	60
6.1.2	Appendages	60
6.2	Propeller	63
6.2.1	Shaft Installation	63
6.2.2	Strut drive	65
6.2.3	In aperture	66
6.2.4	Tractor propellers	66
6.2.5	Twin screws	66
6.3	Residuary Resistance	66
6.3.1	Canoe body - RR surfaces (F_n , BTR , LVR)	66
6.3.2	Canoe body - RR Neural Network model	68
6.3.3	Appendages	70
6.4	Drag due to heel	71
6.5	Induced Drag	71
6.5.1	Correction Factors	74
6.6	Immersed transom	75
6.7	Rail-under drag	77
6.8	Added Resistance in Waves, R_{AW}	77
6.8.1	Wave Climate	77
6.8.2	Determination of added resistance response	78
6.9	Construction material length factor	80
7	Environment	82
7.1	Wind Triangle	82
7.2	Sailing Angles	82
7.2.1	Velocity Made along the Course. (VMC)	82

8 Handicapping	84
8.1 VPP results as used for scoring	84
8.1.1 Velocity prediction	84
8.1.2 Time allowances	84
8.2 Simple scoring options	85
8.2.1 Time on Distance (ToD)	85
8.2.2 Time on Time (ToT)	86
8.2.3 Triple Number	86
8.2.4 Class Division Length (CDL)	86
A Offsets File (.OFF) Format	88
A.1 Introduction to offset format 2.0	88
A.2 Offset format - pre 2021	88
B Neural Networks for RR model	92
Bibliography	95

LIST OF FIGURES

3.1	Force Balance See saw	12
3.2	Force Balance in the plane of the water surface	13
3.3	Roll Moment Equilibrium	14
3.4	Schematic of ORC VPP	15
3.5	Functional relationships in the VPP Boat Model	16
3.6	Foil power axis, area and span definition	20
3.7	Equilibrium scheme for full foiling yacht	21
3.8	DA credit vs. True Wind Angle.	23
3.9	Max penalty for non manual power as function of overall length.	23
4.1	Offset file station distribution and typical section.	24
4.2	Flotation waterline positions.	27
4.3	Bulb and winglet detection scheme	30
4.4	Upper Bulb shape factor examples	31
4.5	Widest point detection	32
4.6	Typical righting arm curve and hydrostatic data output	34
4.7	Typical righting arm curve of a boat with movable ballast	35
5.1	Sail parameters	38
5.2	Basic Sail Force Coefficients	39
5.3	De-powering scheme	40
5.4	Routine for de-powering	41
5.5	Roach calculation	42
5.6	Alternative Mainsail force coefficients	43
5.7	Fractionality Coefficient	44
5.8	shadow effect of the mast portion above	45
5.9	Alternative Jib Force Coefficient	47
5.10	Symmetric, Asymmetric on CL and Asymmetric on Pole Spinnaker Coefficients	49
5.11	Large Spinnakers Force Correction in light winds	50
5.12	Aero coefficients of flying headsail	51
5.13	Typical From of “Collective” Upwind Sail Force Coefficients	55
5.14	Twist Function	56
5.15	Variation of Effective Span Factor with Apparent wind angle	57
5.16	Variation of Drag Coefficient with Flat parameter (left), modification of the linear depowering scheme, f_{cdmult} , (right)	58
6.1	Stripwise segmentation of appendages	61
6.2	Increase of appendage drag with lift.	62
6.3	Propeller Installation Dimensions	64
6.4	Typical Rr multiplier at fixed Froude Number	67
6.5	Flotation planes	68
6.6	Typical Neural Network scheme	69
6.7	LVR-Fn boundaries of RR blending zone	70
6.8	Appendage residuary resistance per unit volume at standard depth.	70
6.9	Induced Drag	72
6.10	Multiplier of induced drag	72
6.11	Scheme of bilgeboards and related variables	73
6.12	Keel root free surface factor	74
6.13	Principle of estimating transom immersion	76
6.14	Wave Energy as a function of True Wind Velocity	78

A.1 Offsets editing through ORC-Manager application 88

LIST OF TABLES

5.1	RS percentages for various rig and sails features	39
5.2	Mainsail force coefficients	43
5.3	Application of Alternative Coefficient sets for Mainsails	44
5.4	Mainsail low tech material credit	45
5.5	Genoa Force Coefficients	46
5.6	Application of Alternative sets for jibs	46
5.7	Change in aerodynamic lift and drag coefficients for roller furling jib.	47
5.8	Symmetric Spinnaker Force Coefficients	48
5.9	Asymmetric Spinnaker tacked on centreline Force Coefficients	48
5.10	Asymmetric Spinnaker tacked on a pole Force Coefficients	48
5.11	Aero coefficients of flying headsails. The names carry a number corresponding to the <i>HHW/HLP</i> ratio. The two rightmost columns are the multipliers of <i>CL</i> and <i>CD</i> for battened sail	52
5.12	Windage force model	53
6.1	<i>L</i> calculation scheme	68
6.2	Hull parameters used by the neural network RR	69
6.3	Added Resistance in Waves; parametric limits and base values	79
6.4	Length factor for construction material	81
8.1	Velocity prediction printed on the 1st page of the ORC International certificate	84
8.2	Time Allowances and Selected Courses on the second page of the ORC International certificate	85
8.3	Simple scoring options on ORC International & ORC Club certificate	85
8.4	Time allowance weighing table	86

REVISION LIST

2026	
Section	Change
par. 3.5	Foiling Yachts Model
par. 5.1.2	<i>RS</i> Rating Assesment
par. 6.3.2	Boundaries on Neural Network Parameters

Beside the above changes, reflecting the modifications introduced in the VPP 2026, further fixes and additions were made to the document.

1 BACKGROUND

The following document describes the methods and formulations used by the Offshore Racing Congress (ORC) Velocity Prediction Program (VPP).

The ORC VPP is the program used to calculate racing yacht handicaps based on a mathematical model of the physical processes embodied in a sailing yacht. This approach to handicapping was first developed in 1978. The H. Irving Pratt Ocean Racing Handicapping project created a handicap system that used a mathematical model of hull and rig performance to predict sailing speeds and thereby produce a time on distance handicap system. This computational approach to yacht handicapping was of course only made possible by the advent of desktop computing capability.

The first 2 papers describing the project were presented to the Chesapeake Sailing Yacht Symposium (CSYS) in 1979 (Kerwin, J.E. and Newman, J.N. 1979, Strohmeier D.D. 1979) . This work resulted in the MHS system that was used in the United States. The aerodynamic model was subsequently revised by George Hazen (Hazen 1980) and the hydrodynamic model was refined over time as the Delft Systematic Yacht Hull Series was expanded (Gerritsma et al. 1993) .

Other research was documented in subsequent CSYS proceedings: sail formulations (2001 (Ranzenbach and Teeters 2001) and 2003 (Teeters J. et al. 2003)), and hull shape effects (2003 (Teeters J. et al. 2003)). Papers describing research have also been published in the HISWA symposia on sail research (Fossati et al. 2008).

In 1986 the current formulations of the IMS were documented by Charlie Poor (Poor 1986), and this was updated in 1999 (Claughton 1999). The 1999 CSYS paper was used as a basis for this document, with members of the ITC contributing the fruits of their labours over the last 10 years as the ORC carried forward the work of maintaining an up-to-date handicapping system that is based on the physics of a sailing yacht.

2 INTRODUCTION

2.1 SCOPE

The following document is a companion to the *ORC Rating Systems 2021* and *IMS (International Measurement System) 2021*. The document provides a summary of the physics and computational processes that lie behind the calculation of sailing speeds and corresponding time allowances (seconds/mile). The current ORC handicap system comprises 3 separate elements:

1. The IMS measurement procedure whereby the physical shape of the hull and appendages are defined, along with dimensions of mast, sails, etc.
2. A performance prediction procedure based on (1) a lines processing procedure which determines the parametric inputs used by the Velocity Prediction Program (VPP) to predict sailing speed on different points of sailing, in different wind speeds with different sails set.
3. A race management system whereby the results of (2) are applied to offer condition-specific race handicapping.

This document describes the methodology of the equations used to calculate the forces produced by the hull, appendages, and sails, and how these are combined in the VPP.

2.2 OVERVIEW

Predicting the speed of a sailing yacht from its physical dimensions alone is a complex task, particularly when constrained by the need to do it in the “general case” using software that is robust enough to be run routinely by rating offices throughout the world. Nevertheless this is what the ORC Rating system aims to do. The only absolute record of the VPP (and companion Lines Processing Program (LPP)) is the FORTRAN source code, so it is a difficult matter for a layman to determine either the intent or underlying methodology by inspection of this code.

The purpose of this document is to describe the physical basis of the methods used to predict the forces on a sailing yacht rig and hull, and to define the formulations (equations) used by the VPP to encapsulate the physical model.

In order to do this the document has been set out to first layout the broadest view of the process, gradually breaking the problem down into its constituent parts, so that ultimately the underlying equations of the VPP can be presented.

2.3 LAYOUT

The document is arranged in 6 chapters:

- Chapter 3 describes the methods by which the velocity prediction is carried out and the fundamental force balances inherent in solving the problem are laid out. Following this an overview of the “boat model” is presented, whereby the elements of the aerodynamic and hydrodynamic model are described.
- Chapter 4 describes how the hull shape parameters are pre-processed to determine the parameters that are used in the hydrodynamic force model described in Section 8.
- Chapter 5 describes how the yacht’s environment is characterized in terms of the incident wind field experienced by the sails.
- Chapter 6 describes how the VPP results are presented as a rating certificate.
- Chapter 7 describes the methods used to predict the aerodynamic forces produced by the mast, sails, and above-water part of the hull.
- Chapter 8 describes how the hydrodynamic drag and lift of the hull and appendages are calculated.

3 VPP METHODOLOGY

The VPP has a two-part structure comprised of the solution algorithm and the boat model. The solution algorithm must find an equilibrium condition for each point of sailing where:

- a) the driving force from the sails matches the hull and aerodynamic drag, and
- b) the heeling moment from the rig is matched by the righting moment from the hull.

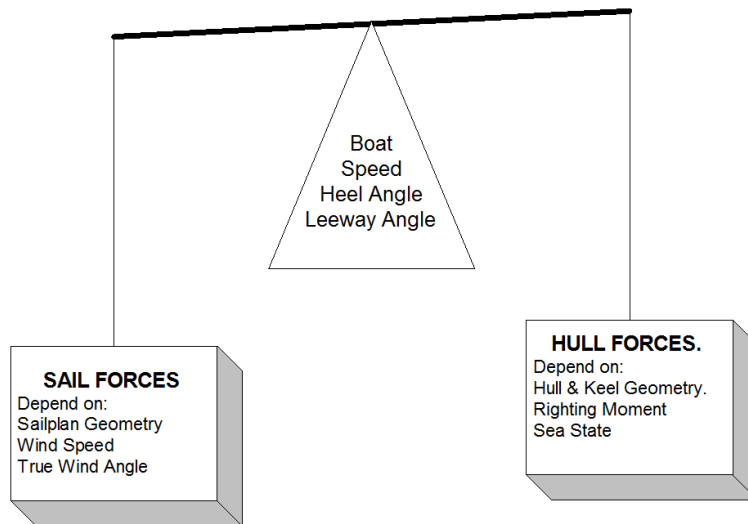

FIGURE 3.1: Force Balance See saw

i.e. balance the seesaw in Figure 3.1(?), and optimize the sail controls (reef and flat) and the crew transverse position to produce the maximum speed at each true wind angle.

3.1 SOLUTION METHOD

The VPP determines the steady state conditions by satisfying 2 equilibrium equations:

1. Firstly the net force - along the yacht’s track (its direction of motion) must be zero,

$$(i.e. \text{ Driving Force} - \text{ Drag} = 0)$$

2. Secondly the aerodynamic heeling moment produced by the mast & sails must be equal and opposite to the righting moment produced by the hull and crew.

$$(i.e. \text{ Heeling Moment} - \text{ Righting Moment} = 0)$$

Figure 3.2 shows a yacht sailing on starboard tack. In order for the yacht to hold a steady course the magnitude and line of action of the aerodynamic and hydrodynamic forces must be the same. The VPP adopts an iterative procedure at each true wind speed and angle to find “equilibrium” sailing conditions, defined by unique values of boat speed (V_s), heel angle (ϕ), and the sail trim parameters (reef, flat) where;

1. Thrust (driving force) from the sails equals the hydrodynamic drag.
2. The heeling moment produced by the couple between the aerodynamic and hydrodynamic Heeling Force equals the hull righting moment, as shown in Figure3.3

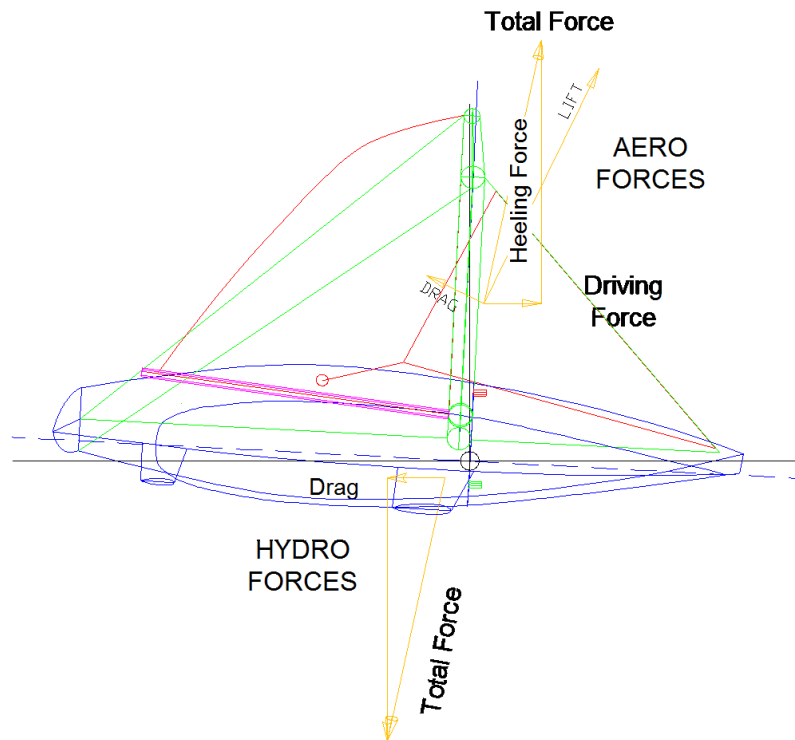

FIGURE 3.2: Force Balance in the plane of the water surface

It should be noted that the VPP solves only for a balance of force and moment about the track axis. The yaw moment balance is ignored so that sail trimming options, or speed and heel values that produce excessive yaw moments, are not reflected in terms of their influence on speed.

3.2 BOAT MODEL

The boat model may be thought of as a black box into which boat speed, heel angle, and the sail trim parameters, reef and flat are input. The output is simply four numbers:

- the aerodynamic driving force,
- the heeling moment from the above water part of the hull and rig,
- the drag of the hull keel and rudder and,
- the righting moment from the hull and crew.

The solution algorithm iterates to a solution by interrogating the boat model with each new guess of the input values until a set of conditions is found that produces a match of thrust and drag and heeling moment and righting moment. The solution algorithm also seeks to find the highest speed on each point of sailing by adjusting the sail trim parameters and the crew righting moment for optimum performance. Figure 3.4 shows how the boat model is divided into two parts:

• Aerodynamic Force Model

For a given wind and boat model variable set (true wind speed V_T , true wind angle β_T , V_s , ϕ , reef, flat), determine the apparent wind angle and speed that the sails 'see' and predict the aerodynamic lift and drag they produce. The aerodynamic forces are resolved into a thrust and heeling force.

• Hydrodynamic Force Model

Predicts the resistance (drag) and righting moment the hull produces for the assumed speed and heel angle, given that the hydrodynamic side force will equal the previously calculated aerodynamic heeling force.

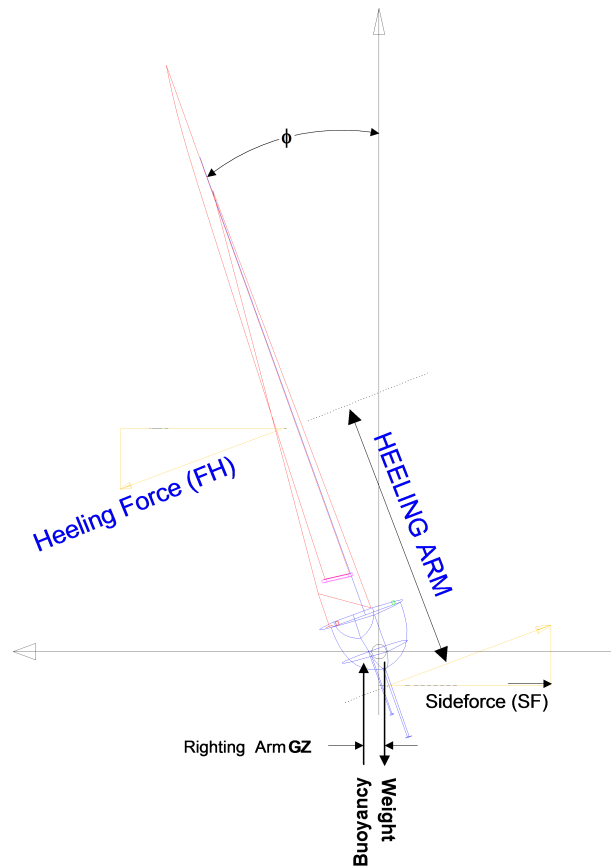

FIGURE 3.3: *Roll Moment Equilibrium*

3.2.1 FUNCTIONAL RELATIONSHIPS

Figure 3.5 shows the functional relationships that make up the elements of the VPP boat model. In order to minimize amount of computational operations within the main iterative VPP loop the Rig Analysis and the Lines Processing parts are carried out before the computations of a steady state solution begin.

RIG ANALYSIS PROGRAM

The Rig Analysis Program takes the measured sail and rig dimensions and calculates the areas and centers of effort for the mainsail, jib and spinnaker. Originally the Rig Analysis Program used the force coefficients for each individual sail to calculate a “collective” set of aerodynamic force coefficients for the rig in an upwind and downwind configuration. This collective table of lift and drag coefficients at each apparent wind angle is interrogated by the solution algorithm during each iteration as the program works towards an equilibrium sailing condition.

More recently¹ for the upwind sailing configurations the calculation of the “collective” sail force coefficients was moved inside the VPP optimization loop so that a more realistic model of sail heeling force reduction could be used.

LINES PROCESSING PROGRAM (LPP)

The Lines Processing program takes the measured hull shape, expressed as an offset file², and calculates the hull dimensions and coefficients that are used to calculate hull drag. The LPP also takes the inclining test results and uses this to determine the yachts stability in sailing trim.

¹2009

².OFF File, a simple txt file of transverse (y) and vertical (z) coordinates of the hull surface at a fixed longitudinal (x) position

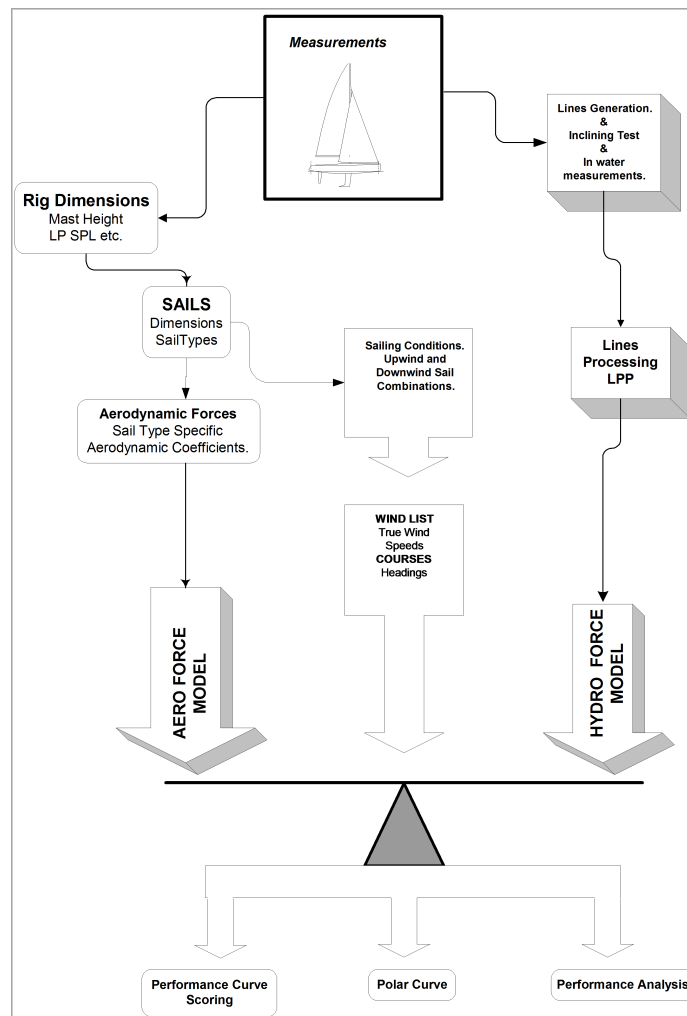

FIGURE 3.4: Schematic of ORC VPP

ITERATIVE SOLVER LOOP

Once these elements have been completed the iterative part of the VPP is started. At each wind speed and true wind angle the process starts with an initial guess at speed and heel angle, given this the wind triangle can calculate the apparent wind speed and angle for the aerodynamic model.

With this information the total aerodynamic force can be calculated, based on the “collective” aerodynamic coefficients. The total aerodynamic force is resolved into the thrust and heeling force (See Figure3.2).

Using the same initial guess for speed and heel angle, plus the calculated heeling force from the aerodynamic force model, the hydrodynamic model can calculate the total hull drag.

The available thrust and the drag can now be compared and a revised estimate of speed can be made, so the heeling moment and righting moment are compared to provide a revised value for heel angle. This process is repeated until speed and heel angle have converged to a steady value. The process is then repeated for a matrix of true wind angles and wind speeds.

The solution routine also includes an optimization element that ensures the sail trim parameters (reef and flat) are chosen to produce the highest speed on each point of sailing. The same routine is used to ensure that the VPP calculates an optimum up-wind and down-wind VMG for each true wind speed. In 2019 the crew righting moment has been included as an additional optimization parameter: the crew weight is moved between the full-to-leeward and the full-to-windward positions, seeking again for the highest boat velocity.

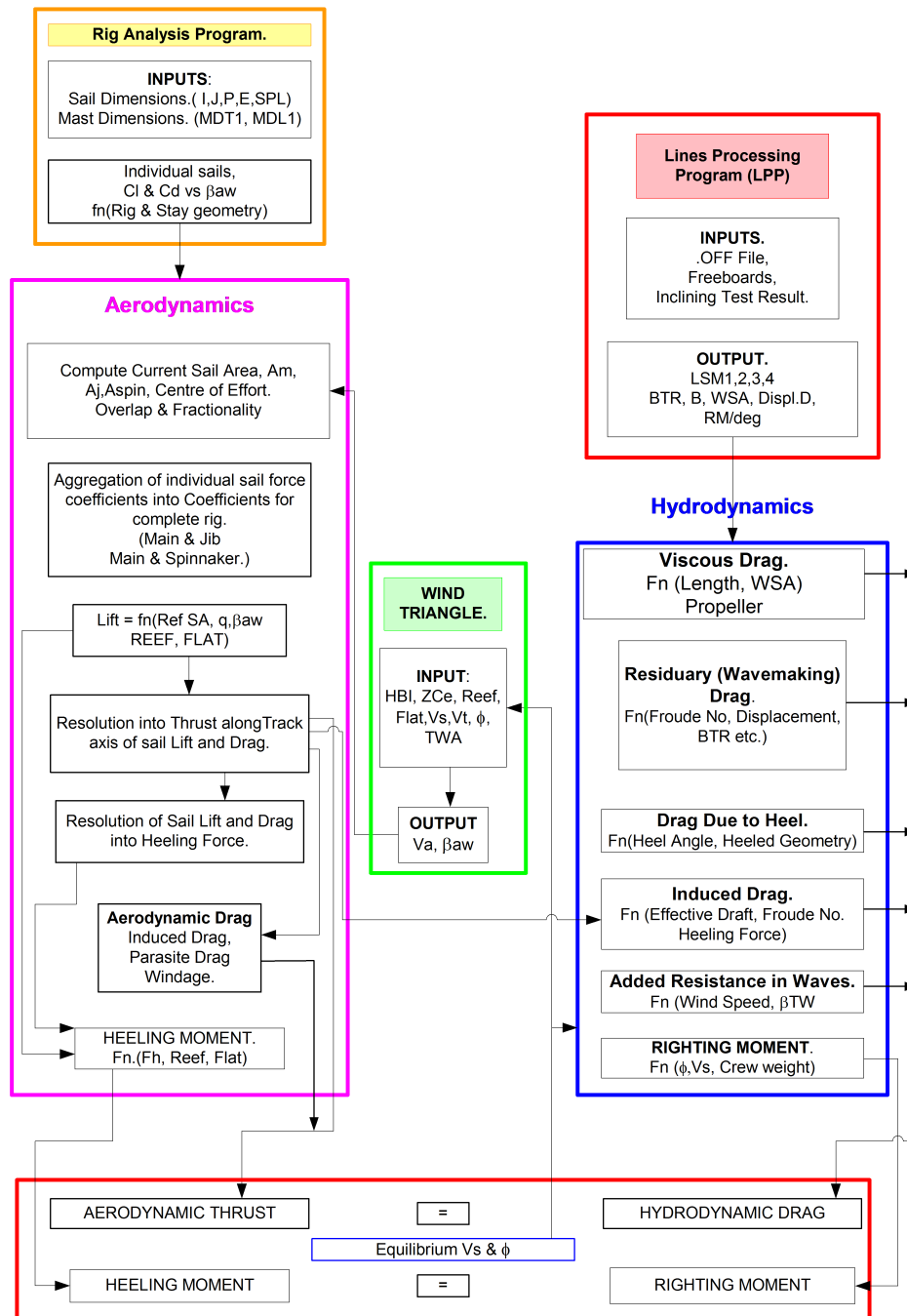

FIGURE 3.5: Functional relationships in the VPP Boat Model

3.3 EQUATIONS OF EQUILIBRIUM

In order to produce a steady state sailing condition the VPP must solve the 2 equilibrium equations matching available driving force to drag, and the heeling moment to the hull righting moment. The accuracy of the VPP prediction is entirely reliant on the accuracy with which these 4 elements can be calculated from parametric data gathered during the measurement process.

3.3.1 DRIVING FORCE - DRAG

This is the basic equation for longitudinal force equilibrium, with the net force along the boat's track being zero:

$$F_{RA} - F_{RW} = 0 \quad (3.1)$$

where:

$$\begin{aligned} FRA &= \text{Total Aerodynamic Thrust} \\ FRW &= \text{Total Resistance} \end{aligned}$$

The total resistance is treated as the sum of 4 separate components, shown in equation 3.2. In reality these divisions are not physically clear-cut, but the approach is adopted to make the problem tractable using a parametric description of the hull and its appendages.

$$FRW = D_{viscous} + D_{residuary} + D_{induced} + D_{raw} \quad (3.2)$$

where:

$$\begin{aligned} D_{viscous} &= \text{Drag due to the friction of the water flowing over the surface of the hull and appendages at the current heel angle, and the propeller if one is fitted.} \\ D_{residuary} &= \text{Residuary Drag, drag due to the creation of surface waves, calculated from the hull parameters at the current heel angle.} \\ D_{induced} &= \text{Induced Drag created when the hull keel and rudder produce sideforce} \\ D_{raw} &= \text{Drag due to the yachts motion in a seaway.} \end{aligned}$$

The aerodynamic driving force is the Aerodynamic driving force less the windage drag of the above-water boat components.

$$FRA = FRA_{b4windage} - FRA_{hull} - FRA_{mast} - FRA_{rigging} - FRA_{crew} \quad (3.3)$$

where:

$$\begin{aligned} FRA_{b4windage} &= \text{Aerodynamic driving force} \\ FRA_{hull} &= \text{Hull windage drag} \\ FRA_{mast} &= \text{Mast windage drag} \\ FRA_{rigging} &= \text{Rigging wire drag} \\ FRA_{crew} &= \text{crew windage drag} \end{aligned}$$

3.3.2 HEELING MOMENT - ROLLING MOMENT

The aerodynamic heeling moment produced by the mast and sails must be equal and opposite to the righting moment produced by the hull and crew.

$$HM_{total} = RM_{total} \quad (3.4)$$

$$HM_{total} = HMA + RM4 \cdot FHA \quad (3.5)$$

$$HMA = HMA_{b4windage} + HMA_{hull} + HMA_{mast} + HMA_{rigging_wire} + HMA_{crew} \quad (3.6)$$

where

$$\begin{aligned} HMA_{total} &= \text{Total heeling moment} \\ RM_{total} &= \text{Total righting moment} \\ HMA &= \text{Aerodynamic heeling moment about the waterplane} \\ RM4 &= \text{Vertical CLR, below waterplane} \\ FHA &= \text{Total aerodynamic heeling force (equal to hydrodynamic force normal to the yachts centre plane)} \\ HMA_{b4windage} &= \text{Aerodynamic heeling moment from sails} \\ HMA_{hull} &= \text{Hull windage heeling moment} \\ HMA_{mast} &= \text{Mast windage heeling moment} \\ HMA_{rigging_wire} &= \text{Rigging wire windage heeling moment} \\ HMA_{crew} &= \text{Crew windage heeling moment} \end{aligned}$$

FHA is the total heeling force:

$$FHA = FHA_{b4windage} + FHA_{hull} + FHA_{mast} + FHA_{crew} \quad (3.7)$$

where

$FHA_{b4windage}$	=	Aerodynamic heeling force from sails
FHA_{hull}	=	Hull windage heeling force
FHA_{mast}	=	Mast windage heeling force
$FHA_{rigging_wire}$	=	Rigging wire windage heeling force
FHA_{crew}	=	Crew windage heeling force

RM_{total} is the total righting moment available from the hull and crew sitting off centerline.

$$RM_{total} = RM_{\phi} - RMV + RM_{aug} \quad (3.8)$$

where

RM_{ϕ}	=	Hydrostatic Righting moment
RMV	=	Stability loss due to forward speed
RMV_{aug}	=	Righting moment augmentation due to shifting crew

3.4 WATER BALLAST AND CANTING KEEL YACHTS

The following section describes the VPP run sequences for yachts with moveable ballast and retractable dagger boards or bilgeboards.

3.4.1 CANTING KEEL

Two VPP runs are made and the best speed achieved on each point of sailing is used to calculate the handicap.

- First VPP run with canting keel on Centre Line (CL) without adding any Righting Moment increase (MHSD computed with the keel on CL)
- Second VPP run with canting keel fully canted adding Righting Moment increase (MHSD computed from the maximum of the two rudders and canted keel.)

3.4.2 DAGGERBOARD (CENTRELINE LIFTING APPENDAGE)

The daggerboard is input to the .DAT file with a special code to identify it as such. Two VPP runs are made and the best speed achieved on each point of sailing is used to calculate the handicap.

- First VPP with the dagger board up. If the yacht has a canting keel this VPP run is done with the keel on centre line.
- Second VPP run with the dagger board down, viscous drag calculated as if it were a conventional fin keel. If the yacht has a canting keel this run is done with the keel at full cant angle. (MHSD is computed with maximum depth based on the keel canted, dagger board down and aft rudder)

3.4.3 DAGGERBOARD AND BILGE BOARDS

Daggerboard and bilgeboards are lifting appendages, the former on the centerline and the latter off centerline. They are added to the .DXT file, by specifying the span, the thickness, the average chord, and also the angle to the vertical, the lateral and longitudinal position. Moreover, it is specified if the board is retractable and to what extent (bilgeboard fraction). When the lateral position is set to zero, this defines a single daggerboard, otherwise two bilgeboards are modelled. Two VPP runs are made and the best speed achieved on each point of sailing is used to calculate the handicap.

- First VPP run with the bilge board up. If the yacht has a canting keel this VPP run is done with the keel on centre line.
- Second VPP run with the leeward bilge board (or daggerboard) down, viscous drag calculated as if it were a conventional fin keel. If the yacht has a canting keel this run is done with the keel at full cant angle. (MHSD computed with maximum depth between keel canted, fwd leeward bilge board down and aft rudder)

3.4.4 WATER BALLAST

Two VPP runs are executed, with and without water ballast; the fastest speed is used for handicapping. When water ballast volume is input directly, the following values are assumed:

$$\begin{aligned} \text{Water ballast VCG} &= 0.50 \times \text{freeboard_aft} \\ \text{Water ballast LCG} &= 0.70 \times \text{LOA} \\ \text{Water ballast Moment arm} &= 0.90 \times \text{crew_arm} \end{aligned}$$

When there are water ballast tanks (one tank on each side) and canting keel, the following runs are performed:

1. tanks empty, keel on CL
2. tanks empty, keel to windward
3. tank to windward filled, keel on CL
4. tank to windward filled, keel to windward

The fastest solution among the above four is taken as the final solution.

In 2016 a new type of water ballast have been introduced in addition to the above one: in this case the ballast is supposed to be shifted to windward when going upwind, but the tanks are not emptied when going downwind. They are called *fresh water ballast*.

3.4.5 MEASUREMENT

Dimensions and locations of dagger boards, bilge boards, forward rudders, etc. can now be added to the .DXT files rather than by direct measurement of their offsets with the wand or laser scanner. For water ballast yachts the volume and location of the water ballast may be edited into the .DXT file instead of by direct measurement.

3.5 FOILING YACHTS

Foiling and semifoiling yachts are becoming more popular, and the ORC VPP has evolved in order to take the foils effect into account. The generation of vertical force changes the equilibrium equations, which must include also the vertical force balance. Moreover, when the boat fully lifts above the water, the hydrostatic role of the hull is completely lost and the heeling moment is counterbalanced only by the righting moment produced by the foils. At present the VPP model distinguishes two cases: the semifoiling one, where the hull is still playing some part in the righting moment generation, and the full foiling one, where the hull is completely lifted up out of the water.

3.5.1 FOILS GEOMETRY AND MODELLING

The foils are complex objects, they can be curved and their orientation could be adjusted. They are defined by a curve described by the leading edge in the three dimensional space (x, y, z) for a number of points. At each point, the chord and the thickness are also set. The details of the shape (the foil section shape) are not known. Furthermore, a *power axis* may be defined, that is an axis of rotation of the appendage, through which the angle of attack may be adjusted. If the power axis is not defined, it is assumed to be directed transversally along the y axis. The foil planform is then approximated by projecting the planform area on a plane parallel to the power axis, thus obtaining the area and span A_F , b_F that will be used in the calculations (see fig.3.6). The direction normal to said plan is the direction of the lift produced by the appendage. The lift, the side force and the vertical force produced by the foil are computed as:

$$\mathbf{L} \simeq C_L q A_F \mathbf{n}_F \quad (3.9)$$

$$L_y = \mathbf{L} \cdot \hat{\mathbf{e}}_y \quad (3.10)$$

$$L_z = \mathbf{L} \cdot \hat{\mathbf{e}}_z \quad (3.11)$$

The appendage produces some induced drag, which is computed as:

$$D_{If} = \frac{C_L^2 q A_F}{\pi A R_e} \quad (3.12)$$

$$A R_e = \frac{2 (0.92 b_F)^2}{A_F} \quad (3.13)$$

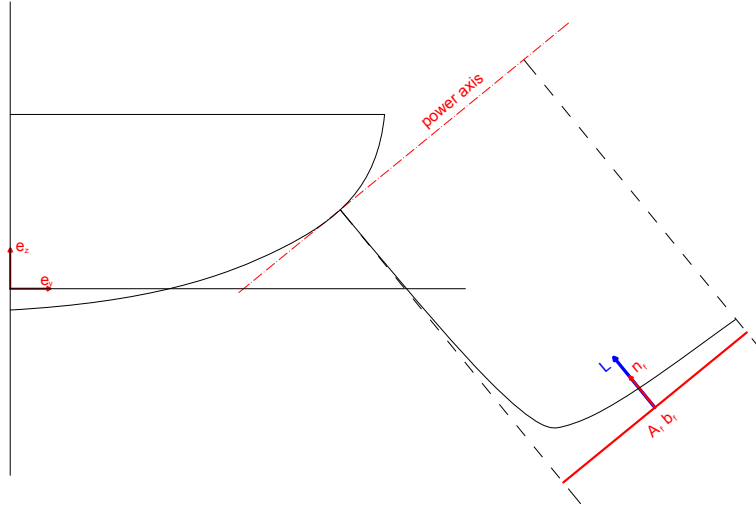

FIGURE 3.6: Foil power axis, area and span definition

The frictional drag is computed in the same way as it is for the other appendages, taking into account only the wetted portion of the appendage.

When more than one foil is present, the lift and the drag are computed one by one and then summed together. The side force of the foil(s)/DSS is then taken into account when computing the induced drag of the hull plus other appendages: this is

$$D_I = \frac{F_y^2}{q \pi T_{eff}^2} \quad (3.14)$$

where $T_{eff} = 1.31 T_{max}$ is the effective draft and the side force F_y that those appendages are supposed to create is the aero side force decreased of the foil side force:

$$F_y = F_{yaero} - F_{yfoils} \quad (3.15)$$

The approach for the solution is to set C_L , the foil lift coefficient, as an optimisation parameter, similarly to reef and flat. Therefore the optimizer searches the value of the lift coefficient that maximizes the boat velocity.

3.5.2 SEMIFOILING

During the solution loop, an initial velocity and heel angle are assumed. Then, the vertical force of the foils is computed:

$$F_{z_{foil}} = C_L \cdot q \cdot A_{Fx} \quad (3.16)$$

where also C_L is an initial guess, bounded to a max value of 0.9, and $A_{x_{foil}}$ is the horizontal projection of foils area. W is the boat weight. Once the vertical force is found, the vertical equilibrium is solved:

$$F_{z_{foil}} + F_{z_{hydrostatic}} - W = 0 \quad (3.17)$$

thus finding the required buoyancy force $F_{z_{hydrostatic}}$ and therefore the submerged volume producing such force. The LPP program has been preprocessing the hull, for a set of drafts, with the aim of creating a functional relation of all the hydrostatic variables (LCB, C_p , LCF, IMSL, IMSB, IMSD, BTR, wetted area, etc...) with the submerged volume, up to a volume representing 50% of the hull volume in measurement trim. This means that all the LPP output is available for any submerged volume between the full displacement down to about 50% of the displacement.

Once the vertical equilibrium is found, setting the hull at the proper draft, the usual solution is started, looking for a solution of the longitudinal force and heeling moment. The foils contribute to the longitudinal drag in terms of frictional and induced drag, and to the righting moment generated by the vertical force being applied sideways to leeward. Also, their side force is taken into account when computing the induced drag of hull and the other appendages.

As said before, the foil lift coefficient is part of the optimisation loop, together with the aerodynamic depowering (flat, reef) and the transverse crew position. All those variables are varied looking for the highest boat velocity.

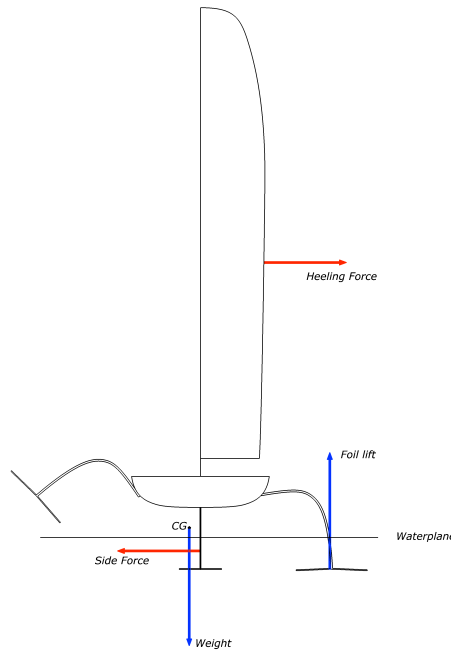

FIGURE 3.7: *Equilibrium scheme for full foiling yacht*

3.5.3 FULL FOILING

When the boat is fully foiling, the hull is completely out of the water, therefore the residuary resistance and the frictional drag are null. Moreover, the hull hydrostatic stability cannot balance anymore the heeling moment produced by the sailplan. This heeling moment must be balanced by the righting moment of the foils, which are located at some transverse distance from the centerplane.

One critical issue is the calculation of the so called *takeoff* speed, that is the boat velocity needed for the boat to takeoff and lift out of the water. This velocity is computed from the relation among C_L , v and the foils horizontal area A_{xfoil} :

$$C_{Lmax} = \frac{W}{0.5\rho v_{takeoff}^2 A_{xfoil}} \quad (3.18)$$

Assuming a maximum value of C_L of 0.9, and knowing the foils area, the relation can be inverted and a takeoff speed computed. For a boat to be considered able to fly at a chosen TWS, this velocity needs to be reached by the boat in semifoiling regime, at least at one TWA.

The boat fully foiling is sustained by a vertical hydrodynamic force equal to its weight, therefore the vertical equilibrium is

$$Fz_{foil} - W = 0 \quad (3.19)$$

and this, at each iteration with initial velocity v , gives the lifting coefficient of the foil planform as a result.

Then, the equilibrium must be found for the other two equations, the longitudinal force (drag-thrust) and the righting moment. The heeling/righting moment equilibrium is driven by the sailplan, because the hydrodynamic part is essentially constant, having already found the C_L of the foils, and therefore the vertical force. It must be said that in the present model only the leeward foil is considered, the windward one is not active, therefore there is no freedom in shifting transversally the point of application of the total vertical force of the foils. For the above reasons, the solution of the heeling/righting moment equilibrium is searched in terms of the depowering, which drives the adjustment of the aero heeling moment so to match it with the fixed righting moment.

The other equilibrium equation, the longitudinal force, maintains its traditional structure, only some terms are no more present, namely those related to the hull being in the water: residuary canoe body drag, canoe body frictional drag, hull added resistance in waves. Moreover, the windage drag is increased by accounting for the hull emerging completely.

3.6 DYNAMIC ALLOWANCE (DA)

Dynamic Allowance is an adjustment which may be applied to velocity predictions (i.e., time allowances) to account for relative performance degradation in unsteady states (e.g., while tacking) not otherwise accounted for in the VPP performance prediction model. DA is a percentage credit calculated on the basis of six design variables deemed to be relevant in assessing the performance degradation and is applied (or not applied) as explained below.

Even where applied, the result of the calculated credit may be zero. The design variables considered are described in section 3.6.1 below. Where applied, the calculated amount of credit will vary with point of sail and wind velocity.

These credits are therefore applied individually to each respective time allowance cell in the large table on the Rating Certificate (see Table 8.2) entitled, “Time Allowances”. The credit is also automatically carried forward into the “Selected Courses” time allowances table, because these course time allowances are comprised of the appropriate proportions of various time allowances from the larger table. Likewise, any credit is carried forward into the General Purpose Handicap (GPH) and the “Simplified Scoring Options”. The single value for DA which is actually displayed on the Certificate is that which was applied to GPH and is shown only to give a comparative reference to the average DA applied for the yacht.

For yachts in the Cruiser/Racer Division that comply with IMS Appendix 1, the DA percentage credits are always fully applied to the time allowances. For other yachts the DA is applied with the same credit only of boats older than 30 years³.

The various credits are derived from a statistical study of a fleet of Cruiser/Racers and Racers, based on IMS L to take into account a scaling factor. For each parametric ratio, an area in the Cartesian plane (Ratio/L) is fixed, limited by two boundary lines which represent a statistical approximation of the Cruiser/Racers and the Racers respectively. For a given “L”, a difference is calculated as the distance between the boundary limits. The individual contribution of each parameter for the given yacht will be the ratio of the distance between the individual yacht’s parameters relative to the Racer boundary line and the previously computed distance between the boundaries, with a cap value for each of the parameters.

3.6.1 CREDITS (2012)

The credits are then calculated as follows:

$$Credit = MaxCredit \cdot \frac{racer_slope \cdot L + racer_incpt - RATIO}{(racer_slope - cruiser_slope) \cdot L + (racer_incpt - cruiser_incpt)} \quad (3.20)$$

where

<i>RATIO</i>	<i>racer_slope</i>	<i>racer_incpt</i>	<i>cruiser_slope</i>	<i>cruiser_incpt</i>	<i>MAX CREDIT</i>
btgsa/vol	0.620	19.0	0.392	15.238	0.75%
runsa/vol	1.000	32.0	0.727	25.093	0.30%
btgsa/ws	0.058	2.39	0.0294	2.38	0.75%
runsa/ws	0.089	4.10	0.059	3.924	0.30%
L/vol	0.062	4.45	0.055	3.985	0.30%

BEATING CREDIT

Applied full strength to VMG Upwind, then linearly decreased to zero at 70° True Wind Angle (TWA), varied with True Wind Speed (TWS) as follows:

$$Beating_Credit = \frac{btgsa \cdot (20 - TWS)}{Wetted_area_credit \cdot (20 - 6)} + \frac{BSA \cdot TWS}{Volume_Credit \cdot 20} \quad (3.21)$$

btgsa/Wetted Area Credit is calculated with complete Sail Area (mainsail + genoa), BSA/ Volume Credit is calculated with Sail Area = Mainsail + foretriangle

RUNNING CREDIT

Applied full strength VMG Downwind, then linearly decreased to zero at 90° TWA, varied with TWS as follows:

$$Running_Credit = \frac{runsa \cdot (20 - TWS)}{Wetted_area_credit \cdot (20 - 6)} \cdot \frac{DSA \cdot TWS}{Volume_Credit \cdot 20} \quad (3.22)$$

³2020

LENGTH/VOLUME RATIO

Applied full strength to all TWA and TWS

3.6.2 CALCULATION PROCEDURE

1. Compute the table of polar speeds and GPH without any credit (like all racing boats)
2. Compute DA credits for each true wind speed and wind angle to obtain a matrix with the same row and columns as the table of speeds.
3. Divide any polar speed of the table by corresponding computed credit and re-calculate the new GPH. To compute the DA value (that is printed on certificate only as reference) the ratio between new and the original GPH is used.

The typical distribution of DA over True wind speed and angle is shown in Figure 3.8

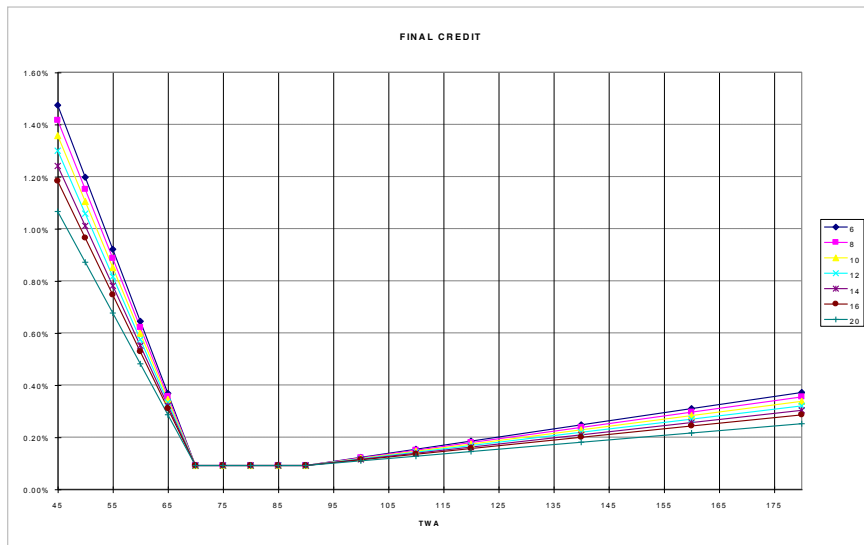

FIGURE 3.8: DA credit vs. True Wind Angle.

3.7 NON MANUAL POWER

Similarly to the Dynamic Allowance, there is another corrector to the overall performance of the boat, which is applied after the solution is calculated in terms of velocities and heeling. The corrector is based on the use of non manual power for adjusting the rig, sail sheets, or both (plus any other manoeuver). Below is displayed the amount of handicap penalty, in percentage, for *full* non-manual power (rig plus sheets). Boats with only *rig* non manual power get the 35% of this handicap penalty, while boats having only *sheets* non manual power get the 65%. The amount depends linearly on the overall boat length LOA, being equal to 0.3% for $LOA \leq 10 m$, then increasing up to a max of 0.6% for $LOA \geq 18 m$.

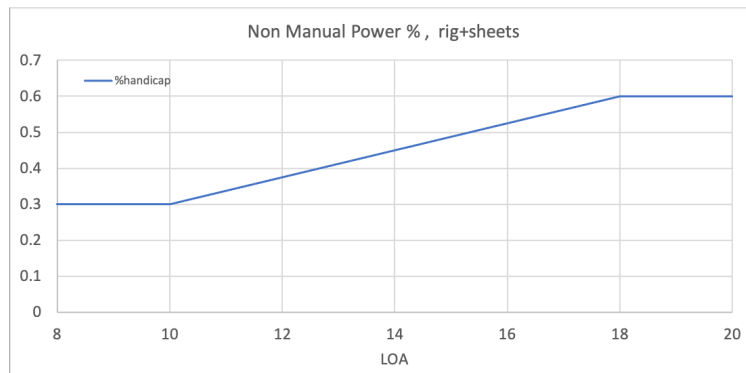

FIGURE 3.9: Max penalty for non manual power as function of overall length.

4 LINES PROCESSING PROGRAM

The LPP is a companion program to the VPP which processes the measurements taken from the hull and appendages into an Offset (.OFF) file and uses this point by point geometric definition to calculate integrated physical quantities that the boat model can use to perform its calculations.

The LPP uses the hull shape defined by the offset file and the results of the inclining test to determine the righting moment at each heel angle.

The LPP uses a definition of hull and appendage shape derived from physical measurement of the hull. The measurement of the hull (wanding) is carried out at pre-determined transverse stations according to the measurement instructions. A typical offset file is shown in Figure 4.1. The format of the .OFF file is described in Appendix A.

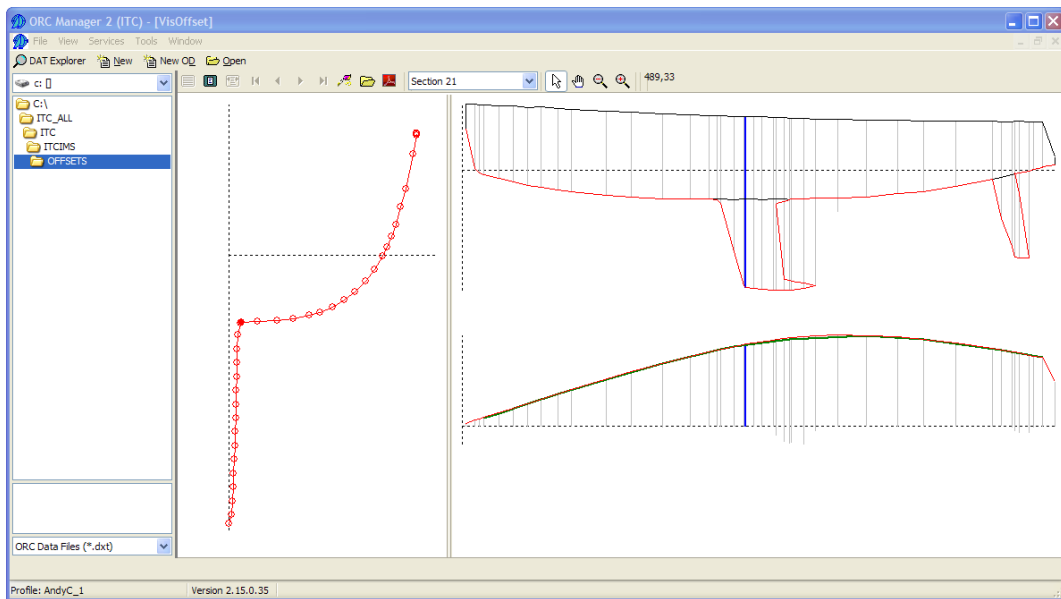

FIGURE 4.1: Offset file station distribution and typical section.

4.1 HYDROSTATICS

As part of the afloat measurements an inclining test is carried out and the freeboards in “Light Ship Trim”¹ are determined. The first task of the LPP is calculate a righting moment vs. heel angle curve for the yacht in its sailing condition. The following steps are carried out:

- Determine measurement trim displacement from the immersed volume of hull and appendages below the flotation waterline, using the offset file as a definition of the immersed hull and appendages
- Use the inclining test results to determine the vertical centre of gravity position (VCG) in measurement trim
- Calculate the displacement and VCG in sailing trim by the addition of weights for crew and gear
- Calculate a righting moment at specified heel angles
- Calculate the Limit of Positive Stability (LPS), the heel angle above which the yacht will capsize

¹2013

4.2 LPP OUTPUT PARAMETER DEFINITIONS

In addition to the traditional “hydrostatic” calculations the LPP also calculates a number of parameters that are used by the hydrodynamic force model. Two fundamental flotation conditions are determined:

4.2.1 MEASUREMENT TRIM

The flotation waterplane is that determined by the measured freeboards with the yacht floating upright. $LSM0$ is calculated in this condition using equation [4.11], and an exponent $nl = 0.25$

4.2.2 SAILING TRIM

In order to achieve the sailing trim and center of gravity, the default crew weight and gear weight and the sail weights are combined and added together. The heights (in meters) are referred to the measurement trim flotation plane.

CREW WEIGHT

The default value for the Crew Weight (kg.) is calculated as follows:

$$crewweight = 25.8 \cdot LSM0^{1.4262} \quad (4.1)$$

The above value cannot be larger than 50% of the displacement in light ship trim. The owner may accept the default calculated weight, but can declare any crew weight which shall be recorded in the certificate. The declared crew weight is used to compute increased righting moment while default crew weight will be used to compute sailing trim displacement.

The longitudinal and vertical position of the combined crew longitudinal centre of gravity are:

$$crewl = 0.1 \cdot LSM0 + LCB \quad (4.2)$$

$$crewv = 0.05 \cdot LSM0 + 0.36 \quad (4.3)$$

$$(4.4)$$

GEAR WEIGHT

Gear weight is calculated from equation below, that models a contribution related to the crew size, named *CrewGearWeight* and a contribution related to the boat size named *BoatGearWeight*

$$\begin{aligned} Gear_Weight &= Crew_Gear_Weight + Boat_Gear_Weight & (4.5) \\ Crew_Gear_Weight &= \min(0.03 \cdot displ, 0.096 \cdot crewweight) \\ Boat_Gear_Weight &= \min(0.055 \cdot displ, 33 + 0.75 \cdot LSM0^{2.1}) \end{aligned}$$

where the displacement is taken in lightship trim.

SAILS WEIGHT

In 2020 the sails weight has been reformulated taking indirectly into account the pressure acting on the sails, by introducing the righting moment in the formulation. Below, A_{main} , A_{jib} and A_{spin} are the areas of the largest main, jib

and spin found in the sail inventory, DHK is the keel draft.

$$\begin{aligned}
arm &= P + BAS + HBI + DHK \\
SA &= A_{main} + A_{jib} + A_{miz} \\
k1 &= \frac{RM25}{0.43 \cdot arm \cdot SA} \\
mw &= (k1 \cdot 0.00065 \cdot A_{main}^2 + 0.12 \cdot A_{main}) + 1.5 \\
jibw &= (k1 \cdot 0.00091 \cdot A_{jib}^2 + 0.12 \cdot A_{jib}) + 1.5 \\
spinw &= \max(k1 \cdot \frac{0.0013}{30} \cdot A_{spin}^2, 0.08 \cdot A_{spin}) \\
hsfw &= \max(k1 \cdot \frac{0.0013}{30} \cdot A_{tothsf}^2, 0.08 \cdot A_{tothsf}) \\
rnjibs &= 3.16 + 0.2345 \cdot LSM0 \\
rnjibs &= rnjibs - nhsf \\
rnspins &= 1.16 + 0.2345 \cdot LSM0 \\
osailsw &= jibw \cdot \max(rnjibs \cdot 0.5, 1) + spiw \cdot \max(rnspins \cdot 0.6, 1) + hsfw
\end{aligned} \tag{4.6}$$

In the above formulas, A_{tothsf} is the cumulative total area of the declared headsails set flying, and $nhsf$ is the declared number of headsails set flying. The terms $rnjibs$ and $rnspins$ are continuous functions fitting at best the ORC rules for maximum number of sails on board. $rnjibs$ is bounded by 5 at the bottom and 8 at the top, similarly $rnspins$ is bounded by 3 and 6. They depend by $LSM0$ because the CDL , which is used the ORC rules, is not known until the end of the VPP run. The headsail set flying weight calculation takes into account the real number of sails declared on board, which also acts as a constraint when computing the number of jibs on board. The weighs then added for computing the sailing trim are mw (mainsail weight) and $osailsw$ (other sails weight), this last summing up the weighs of luffed headsails (jibs), headsails set flying, and spinnakers.

The longitudinal position of mainsail weight and of other sails are respectively:

$$mswl = 0.03 \cdot LSM0 + LCB \tag{4.7}$$

$$oswl = -0.095 \cdot LSM0 + LCB \tag{4.8}$$

while the vertical positions are:

$$mswv = 0.33 \cdot P + BAS + HBI \tag{4.9}$$

$$oswv = 0.012 \cdot LSM0 - 0.32 \tag{4.10}$$

4.2.3 SECOND MOMENT LENGTH (LSM)

$$LSM = 3.9232 \cdot \left[\frac{\int x^l s_5 dx}{\int s_5 dx} - \left(\frac{\int x s_5 dx}{\int s_5 dx} \right)^l \right]^{1/l} \tag{4.11}$$

where:

$$s_5 = \left[\int_S \exp\left(-\frac{a \cdot z}{LSM0}\right) dS \right]^t \tag{4.12}$$

- s_5 = an element of sectional area attenuated for depth
- x = longitudinal coordinate
- l = Length Exponent
- t = Section Exponent
- a = Attenuation Exponent
- z = immersion below waterplane

The values of the three integration exponents are: $l = 2$, $t = 0.25$, $a = 10$.

This method of deriving the Effective sailing length from a weighted sectional area curve is a legacy of the original MHS system. Originally the length calculation took note of the longitudinal volume distribution of the hull, rather than include directly in the residuary resistance calculation terms that were calculated from the sectional area curve.

The depth attenuation of sectional areas, as shown in eq.(4.12) is performed by multiplying each area element by $e^{(-10 \cdot z / LSM0)}$.

The LPP uses the physical shape of the canoe body, as defined by the .OFF offset file, to calculate immersed lengths at several different waterplane positions. The integration is carried on the canoe body only², after the appendages have been stripped out (*clipped*, in the LPP jargon).

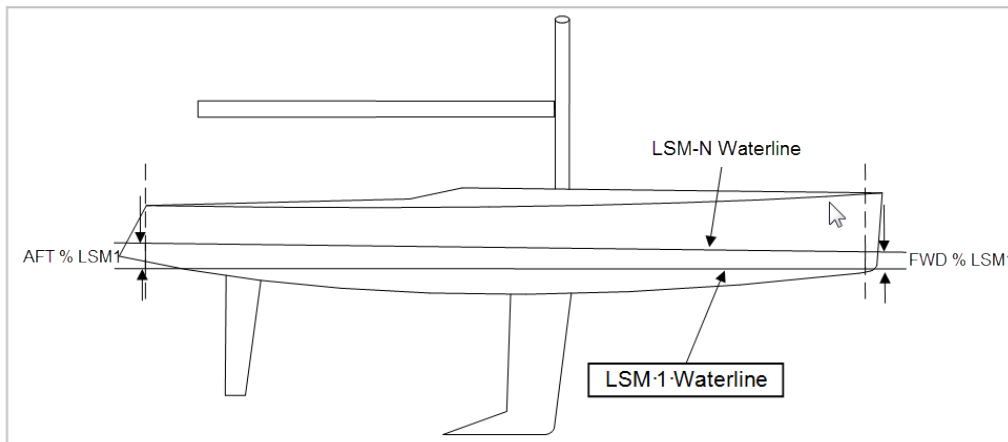

FIGURE 4.2: Flotation waterline positions.

4.2.4 APPENDAGE STRIPPING

Once the offset file has been acquired and checked, the LPP “strips” off the appendages to leave a “fair” canoe body. Various hydrostatic characteristics and physical parameters are calculated using the flotation waterline determined at the in-water measurement. The characteristics of the appendages are handled separately to determine the parameters that affect their resistance.

4.2.5 BEAM DEPTH RATIO (BTR)

The LPP also computes the effective beam and draft of the yacht's canoe body, along with the maximum effective draft of the keel. The Beam Depth Ratio (BTR) is the effective beam (B) divided by the effective hull depth (T).

$$BTR = \frac{B}{T} \quad (4.13)$$

THE EFFECTIVE BEAM (B)

The effective beam is calculated based on the transverse second moment of the immersed volume attenuated with depth for the yacht in Sailing Trim floating upright. This approach “weights” more heavily elements of hull volume close to the water surface.

$$B = 3.45 \cdot \sqrt{\frac{\frac{2}{3} \cdot \iint (b^3 e^{-10z/LSM0}) dz dx}{\iint (b e^{-10z/LSM0}) dz dx}} \quad (4.14)$$

where

- b = an element of beam;
- e = is the Neperian base, 2.7183
- z = is depth in the vertical direction
- x = is depth in the fore and aft direction

²2023

EFFECTIVE HULL DEPTH (T)

The Effective Hull Depth is a depth-related quantity for the largest immersed section of the hull. It is derived from the area of the largest immersed section attenuated with depth for the yacht in Sailing Trim floating upright (AMS2) divided by B:

$$T = 2.07 \cdot \frac{AMS2}{B} \quad (4.15)$$

MAXIMUM SECTION AREAS

Maximum section areas used for the derivation of Effective Hull Depth (T).

AMS1 is the area of the largest immersed section for the yacht in Sailing Trim floating upright. AMS2 is the area of the largest immersed section attenuated with depth for the yacht in Sailing Trim floating upright.

Formulae for Maximum Section Areas, (where b is an element of beam; e is the Napierian base, 2.7183; and z is depth in the vertical direction):

$$\begin{aligned} AMS1 &= \text{maximum of } \int b dz \text{ over length} \\ AMS2 &= \text{maximum of } \int b \cdot e^{-10z/LSM0} dz \text{ over length} \end{aligned}$$

4.2.6 MAXIMUM EFFECTIVE DRAFT (MHSD)

To inform the calculation of hydrodynamic induced drag (drag due to lift³) during the VPP force balance calculations the “effective draft” of the hull and keel combination must be calculated.

The value of the effective draft (MHSD) is determined by the LPP using the original expression for a “reduced draft” (TR) which is calculated based on the local section maximum draft and hull cross sectional area. This expression which treats the hull and keel as one half of a slender axi-symmetric body, calculates the effect of streamline contraction around the canoe body. In this way the influence of a deep hull on effective draft is accounted for.

The maximum effective draft of the keel is found by calculating the following parameters at each immersed station along the length of the hull.

$$\begin{aligned} TRMAX &= xxy1 = \text{Maximum reduced draft} \\ TRD &= xxy = \text{Centreline immersed depth} \\ TRSA &= \text{sectional area.} \\ TRX &= \text{longitudinal location of station} \\ S(i) &= \text{the sectional area at station } i \\ Xxy &= \text{centerline immersed depth of station } (i) \end{aligned}$$

$$xxb = \sqrt{\frac{4 \cdot S(i)}{\pi \cdot BTR}} \quad (4.16)$$

$$xxr1 = 0.5 \cdot \left(\frac{xxy}{xxb} + \sqrt{\left(\frac{xxy}{xxb}\right)^2 + 0.25 \cdot BTR^2 - 1} \right) \quad (4.17)$$

$$xxr2 = \sqrt{xxr1^2 - 0.5 \cdot (1 + 0.5 \cdot BTR)} \quad (4.18)$$

$$xxy = xxb \cdot \left(xxr2 - \frac{0.25 \cdot (0.25 \cdot BTR^2 - 1)}{xxr2} \right) \quad (4.19)$$

These computed quantities are only important as intermediate results. The information is stored for the station yielding the greatest value of $xxy1$, “MHSD” (MHS draft), and is determined from:

$$MHSD = 0.92 \cdot \max(xxy1) \quad (4.20)$$

CENTERBOARDS

Centerboards, drop keels, dagger boards etc. are treated in a similar manner. In the calculation of xxb $S(i)$ is taken as the cross sectional area for the section at the same longitudinal position as the point of maximum draft for the

³described in section 6.5

appendage. Also xy is now taken as the corrected draft for the hull with the fixed keel plus the corrected centerboard extension (ECE).

$$xxb = \sqrt{\frac{4 \cdot S_{(max_depth)}}{\pi \cdot BTR}} \quad (4.21)$$

$$DEF = DHK_{effective} + ECE \quad (4.22)$$

$$xxr1 = 0.5 \cdot \left(\frac{DEF}{xxb} + \sqrt{\left(\frac{DEF}{xxb} \right)^2 + 0.25 \cdot BTR^2 - 1} \right) \quad (4.23)$$

$$xxr2 = \sqrt{xxr1^2 - 0.5 \cdot (1 + 0.5 \cdot BTR)} \quad (4.24)$$

$$xy1 = xxb \cdot \left(xxr2 - \frac{0.25 \cdot (0.25 \cdot BTR^2 - 1)}{xxr2} \right) \quad (4.25)$$

MHSD is again calculated from the formula

$$MHSD = \max(0.92 \cdot xy1, MHSD_{nocenterboard}) \quad (4.26)$$

TWIN (DOUBLE) KEELS AND BULBS

The twin keel is defined by the following inputs⁴:

- keel distance from bow
- vertical span
- mean chord lengths and thicknesses
- y-offset (distance from CL of fin)
- angle of fin to vertical

The viscous drag is calculated using the method described in Section 6.1.2, with the exception that the keels are not divided into horizontal stripes for the purpose of calculating the local section characteristics. The induced drag is calculated using the standard method described in section 6.5

The bulb is defined by the following inputs:

- Length
- max width
- max height

With these data the following bulb parameters are computed, which are then used to calculate the frictional and residuary resistance with the usual schemes (6.1.2 and 6.3.3):

$$\begin{aligned} \text{thickness_chord_ratio} &= \text{width/length} \\ \text{wetted_area} &= 1.10 \cdot (\text{width+height}) \cdot \text{length} \\ \text{volume} &= 0.5 \cdot \text{width} \cdot \text{height} \cdot \text{length} \end{aligned}$$

4.2.7 BULB/WING EFFECTS

The geometry of the keel tip is influential on the induced drag of the keel fin. These effects may be both positive and negative,

- A ballast bulb with circular (or elliptical) cross section reduces the effect span of the keel fin.
- A well designed wing keel extends the effective span of the keel.

The VPP contains an algorithm which detects the type and degree of “bulb” keel or “wing” keel and modifies the effective span, derived according to section 4.2.6.

⁴2011

DEFINITIONS

DHK0	geometric overall draft of keel
MAXW	max width of keel
TMAXW	draft at max width of keel
	<i>MAXW and TMAXW are corrected by "10° line test"</i>
FLAGBULB	1 if bulb is detected
FLAGWING	1 if winglets are detected
UPBULBF	upper shape factor for bulb
DeltaD	effective draft correction due to bulb and/or winglet.

WINGLET DETECTION

Winglets exist if a line from the maximum width location to a point located in a vertical plane of symmetry, in the same transverse section, vertically distant from the maximum width location less than MAXW/4 which does not lie somewhere in keel (Figure 4.3-1). Then WWING width is added by the wing.

BULB DETECTION

If winglets are not detected, a bulb exists if a line from the maximum width location to a point located in vertical plane of symmetry, in the same transverse section, vertically distant from max width location less than MAXW which does not lie somewhere in keel (Figure 4.3-2). Then WBULB is width added by bulb.

BULB + WINGLET DETECTION

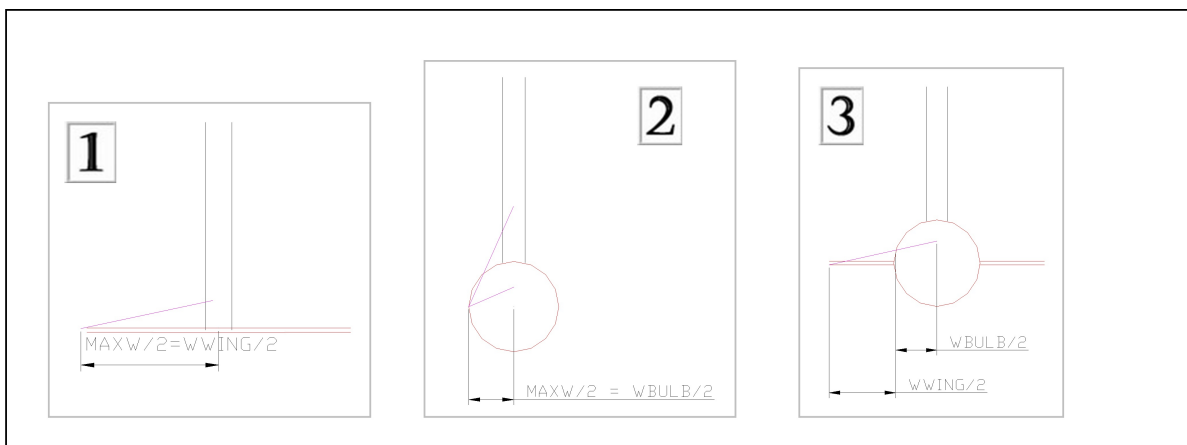

FIGURE 4.3: Bulb and winglet detection scheme

In any case: $MAXW = WBULB + WWING$ (Figure 4.3-3)

DELTA D FORMULAS

DeltaD is calculated with the following formulae and then corrected by the "limitations" defined below. The formulations are based on CFD calculations for eight bulb or winglet configurations. The multiplier of 0.5 applied to $f2$ is an arbitrary reduction of the bulb credit.

$$\frac{\Delta D}{MHS D} = \frac{D H K 0 - T M A X W}{0.5 \cdot M A X W} \cdot \left(F l a g b u l b \cdot U P B U L B F \cdot 0.5 \cdot f 2 \left(\frac{W B U L B}{D H K 0} \right) \cdot \frac{W B U L B}{F l a g w i n g \cdot W W I N G + W B U L B} \cdot F l a g w i n g \cdot f 3 \left(\frac{M A X W}{D H K 0} \right) \right) \quad (4.27)$$

Note that:

- $f2$ addresses the bulb effect if there is no winglet

- $f3$ addresses winglet effect if there is no bulb
- the case where bulb and winglet exist the interactions are taken into account by multiplying $f2$ value by the $WBULB/(Flagwing * WWING + WBULB)$ term

where:

$$\begin{aligned}
 f1(X) &= 1 + k1 * X && \text{if } X < 1 \\
 &= 1 + k1 && \text{if } X > 1 \\
 f2(X) &= k2_0 + k2_1 * (X - wbu_T0) && \text{if } X > wbu_T0 \\
 &= k2_0 * X / wbu_T0 && \text{if } X \leq wbu_T0 \\
 f3(X) &= k3_0 * X / wwi_T0 && \text{if } X < wwi_T0 \\
 &= k3_0 + k3_1 * (X - wwi_T0) && \text{if } X \geq wwi_T0
 \end{aligned}$$

$k1$	0.6
$k2_0$	-0.06
$k2_1$	0.19
$k3_0$	0.05
$k3_1$	0.02
wbu_T0	0.15
wwi_T0	0.5

UPPER SHAPE FACTOR FOR BULB

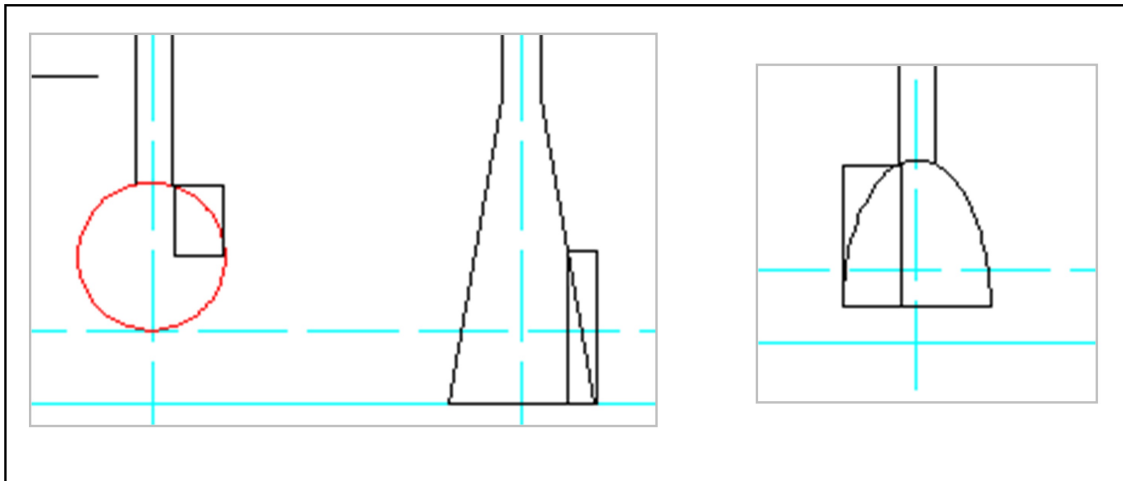

FIGURE 4.4: Upper Bulb shape factor examples

UPBULBF is introduced to take into account that end effect of the bulb depends of the shape of the top of the bulb. A straight shape (e.g. a Scheel Keel) has a positive effect, although a round shape has negative effect on effective draft.

Moreover UPBULBF helps to smooth the jump of ΔD when a bulb becomes winglet. UPBULBF is defined as follows:

1. Consider the rectangle defined by opposite corners at the maximum width bulb point and a point on the top surface of the bulb located at $0.05 * DHK0$ off the centerline. Calculate the area Ar
2. Consider the enclosed part of the bulb in the rectangle. Calculate the area Abu
3. Define the upper bulb shape factor $UPBULBF = f4(Abu/Ar)$: $f4(1) = 1$ for $x = 0.825$, $f4(0.3) = 0.3$, $f4$ linear function.
4. In the bulb wing formula, multiply $f2$ by $UPBULBF$.

LIMITATIONS

$\Delta D > -0.025 * D_{HK0}$ (credit bulb limitation)

If the widest point of the bulb or winglet is not enough deep with respect to D_{HK0} and $MAXW$, the bulb or winglet are considered to have no effect:

$\Delta D = 0$ if $T_{MAXW} + 3 * MAXW / 2 < D_{HK0}$

ΔD is not affected if $T_{MAXW} + MAXW / 2 > D_{HK0}$

ΔD varies linearly between those two situations.

SMOOTHING TECHNIQUE

Because the detection scheme must work on old offset files, which may have sparse data points in the area of the keel tip, it is important to avoid catching spurious “widest points”. When, going down along the bulb/winglet section, the point of max width is found, at that point the “10 deg line test” is applied.

The test is to trace an almost vertical line downward, inclined 10 degrees inboard. The lowest offset point that lies “external” to that line is taken as the widest point of the section, in way of the actual widest point. At this point the test is applied for winglet and bulb (see Figure 4.5).

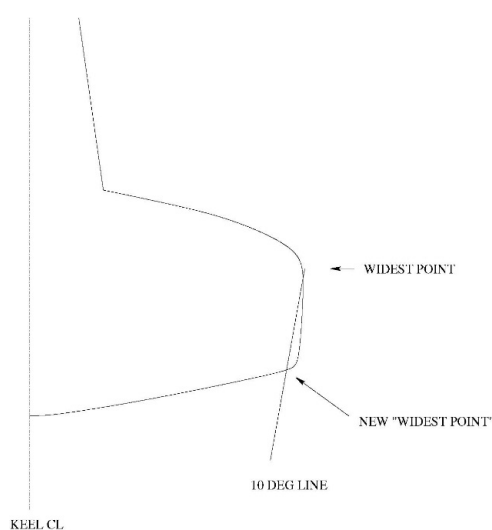

FIGURE 4.5: Widest point detection

4.3 APPENDAGE WETTED AREAS AND LENGTHS

The original VPP formulations were concerned only with “conventional” fin keel and rudder configurations. Subsequently the ability to handle off-center appendages, and canting keels has been added.

4.3.1 CONVENTIONAL FIN KEEL AND RUDDER

The keel and rudder are divided into 5 horizontal strips and a wetted surface area together with a mean length and thickness to chord ratio is calculated for each strip⁵. These values are used to calculate the viscous resistance of the appendages. In this case the volume of the fin keel and any associated bulb is calculated so that the contribution to wave making resistance may be calculated.

4.3.2 OTHER APPENDAGES

The LPP can deal with twin rudders, centerboards, forward rudders, fixed or retractable dagger boards. These appendages can be added into the .DXT file based on their measured dimensions, rather than including them in the

⁵up to 2015 the wetted area of second to fifth strip was the *projected* area of the strip on to the centerplane. For the first strip the real wetted area was used, because this is the strip containing the bulb, if there is one. After discovering that for some configuration the bulb was partially in the second strip, since 2016 for all the appendages the real wetted area is used.

wanded .OFF file data. Only the viscous drag of these appendages is calculated, based on methods described in detail in section 6.1.2. The LPP also calculates any reduction of wetted surface area that occurs if any dagger board, twin rudder etc. comes above the flotation waterline.

4.4 RIGHTING MOMENT

The righting moment balances the heeling moment produced by the sailplan, and is the sum of several components:

$$RM = RM_{hull} + RM_{crew} + RMV + RM_{movable-ballast} + RM_{DSS} \quad (4.28)$$

where the hull term is the restoring moment of the hull in sailing displacement, the second is the moment generated by moving the declared crew weight on the rail, RMV is the dynamic righting moment, and RM_{DSS} and $RM_{movable-ballast}$ are the contributions of the movable ballast (canting keel and/or water ballast) and of the Dynamic Stability System, whenever they are present.

4.4.1 RIGHTING ARM CURVE

The LPP calculates a righting arm against heel angle curve (Figure 4.6), for the boat in sailing displacement.

For a boat with movable ballast the curves are two, one with the ballast on the CL, the second with the ballast on one side: this latter is non symmetric through the (-180,180) degrees range of heel, and includes both the terms $RM_{hydrostatic}$ and $RM_{movable-ballast}$ of formula (4.28). An example is shown in Fig.4.7. The portion between 0 and 180 degrees has the ballast to windward, while the range between -180 and 0 is calculated with the ballast to leeward, and has opposite sign because of the way the arm is defined: within this range a negative righting arm means positive stability.

4.4.2 HYDRODYNAMIC CENTRE OF PRESSURE

The hydrodynamic vertical center of pressure $RM4$ is given by:

$$RM4 = 0.43 \cdot T_{max} \quad (4.29)$$

where T_{max} is the maximum draft.

4.4.3 CREW RIGHTING MOMENT

The crew righting moment is based on the declared crew weight or a default crew weight calculated from $CW = 25.8 \cdot LSM^{1.4262}$. The assumed individual crew weight is 89 kg and the number of crew is calculated by dividing the crew weight by this value.

LSM GREATER THAN 4.9M (16 FEET)

When $LSM > 4.9 m$, two less than the total number of crew are distributed along the deck edge of the boat centered about the assumed centre of gravity position, a single crew member is assumed to occupy a width of 0.53m.

The lever arm of the crew on the rail is the average hull beam over the length of side deck occupied by the crew. The remaining 2 crew members, the helmsman and main trimmer are assumed to have transverse centre's of gravity at 70% of the yachts maximum half beam.

For Sportboats a Crewarm Extension Factor (CEXT) may be used, which takes into account the more radical transverse position of the crew for this boat types having hiking straps and/or trapezes. Crew hiking is assumed to have a righting arm 0.5 m outside of the rail, while crew on the trapeze is supposed to have an arm 1.2 m outside of the rail.

$$Crew \cdot rightingarm = \left(CARM \cdot CREWRW + 0.7 \cdot 2 \cdot \frac{B_{max}}{2} \cdot bodywt \right) \cdot \cos(heel) \quad (4.30)$$

where:

CARM	=	Crew righting arm
CREWRW	=	Crew weight on the rail
Bmax	=	Hull maximum
bodywt	=	Average crew body weight.
heel	=	Heel angle

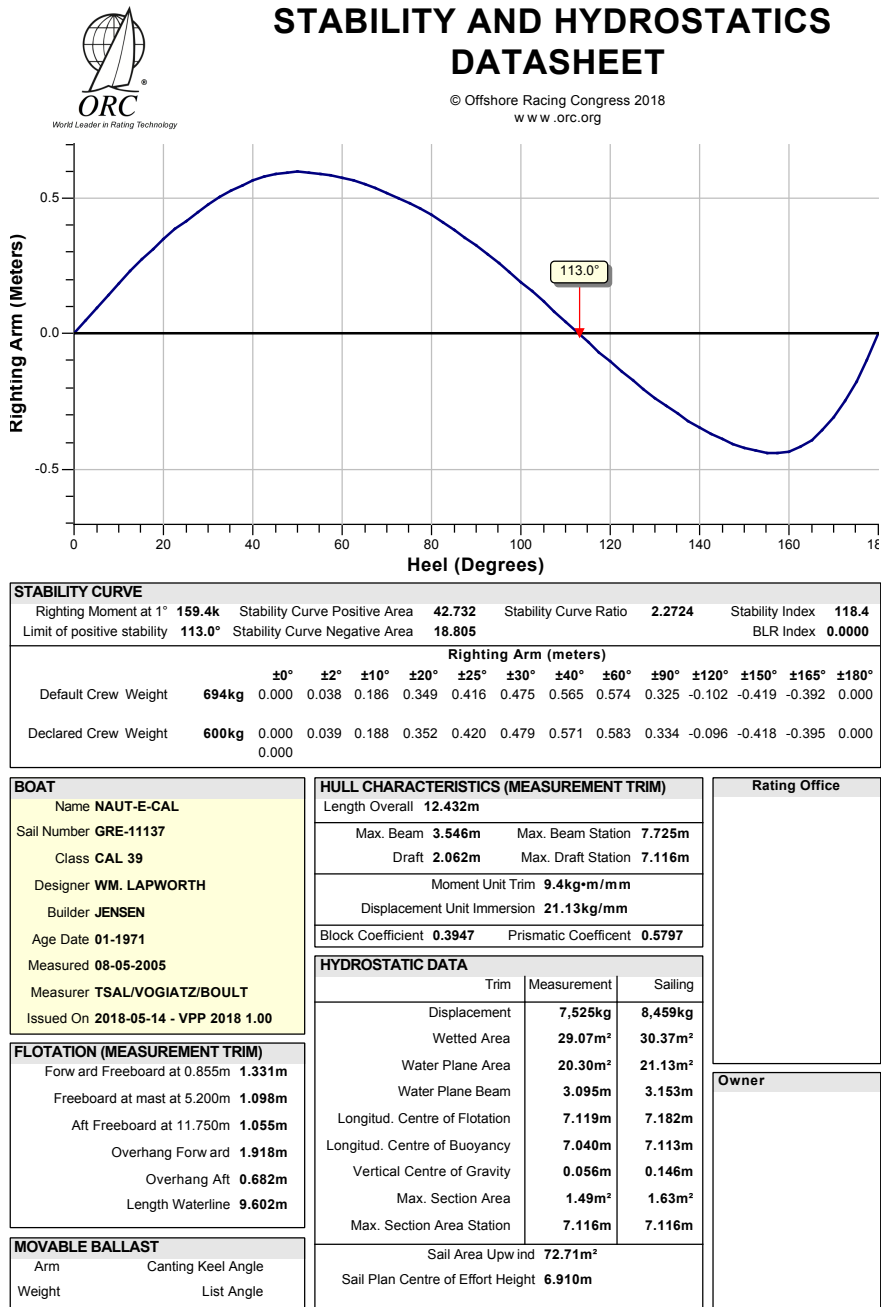

FIGURE 4.6: Typical righting arm curve and hydrostatic data output

LSM LESS THAN 4.9M

For yachts with LSM less than 4.9 m the crew weight is all sat on the rail.

$$Crew \cdot rightingarm = (CARM \cdot CREWRW) \cdot \cos(heel) \tag{4.31}$$

CREW WEIGHT TRANSVERSE POSITION

Up to 2018 the crew transverse position followed a prescribed law established for all yachts: the crew was sat on the leeward side up to a certain heel and the smoothly moved to windward. Since 2019 the crew trasverse position (better, its righting or heeling moment) is used as an optimisation parameter, searching for the position that maximises the boat velocity (or vmg), exactly in the same way as the sail depowering parameters are used. As a consequence the solvers looks for each boat at the ideal heel angle at each specific sailing point (TWS and TWA).

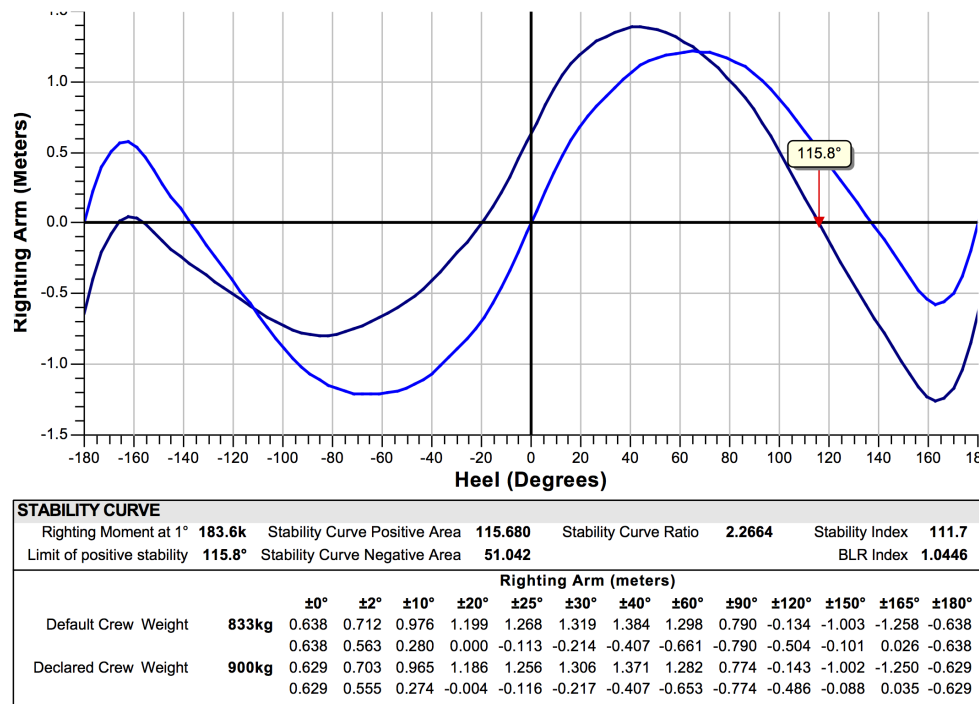

FIGURE 4.7: Typical righting arm curve of a boat with movable ballast

4.4.4 DYNAMIC RIGHTING MOMENT. RMV

RMV is a term intended to account for the difference between the hydrostatic righting moment calculated by the LPP, and the actual righting moment produced by the hull when moving through the water. This term was in the VPP from its first implementation⁶.

$$RMV = \frac{5.955 \cdot 10^{-5}}{3} \cdot DSPL \cdot LSM \cdot \left(1 - 6.25 \frac{B_{cb}}{\sqrt{AMS1_{cb}}} - 2.1 \right) \cdot SLR \cdot \phi \quad (4.32)$$

where

$DSPL$	=	Displacement
B_{cb}	=	Canoe body beam
$AMS1_{cb}$	=	Maximum section area of canoe body
SLR	=	Speed length ratio

DYNAMIC STABILITY SYSTEM (DSS)

The DSS is the deployment of an approximately horizontal hydrofoil on the leeward side of the yacht that generates a vertical force component to augment the yachts righting moment. Since 2010 the VPP is able to calculate the drag and increased righting moment available from a DSS. The data input file take in the geometrical data of the foil's size and position and use a simple algorithm to calculate the increased righting moment of the foil. The lift force is proportional to the square of the yachts speed, and the maximum extra righting moment capped at a percentage of the yachts typical sailing righting moment. Like all features of the ORC VPP this force prediction algorithm is intended to provide an equitable handicap for yachts fitted with the DSS. It is not a "design and optimization" tool.

4.4.5 RATED RIGHTING MOMENT

In 2008 the ORC introduced the *rated* righting moment RM at one degree of heel: it was computed as a weighted average between the measured righting moment and a so-called *default* righting moment, this last being a determination based on general parameters of the boat, like displacement, sail area, beam etc..., not strictly linked to the boat

⁶The divisor of 3 in the first term was introduced in 2000 to correct an over-prediction of RMV for contemporary hull forms

itself. The reason behind this approach was to decrease the sensitivity of the performance prediction to the measured righting moment, which had lead to the undesirable effect of producing too tender competitive boats. In 2015 it was felt that the trend toward stable and fast boats was well established, and a the weight of the *default* RM was reduced from 50% to 33%. For 2023, after further modifying the aero depowering scheme, the contribution of the *default* righting moment has been nullified.

The *default* RM formulation remains valid for Club boats not having an inclining experiment, where the Rating Office instead of guessing the stability through a manual input of RM or VCG, prefers to leave the calculation to the program, that uses the calculation described here below in detail.

$$RM@1_{default} = 1.05575 \cdot \left(a0 + a1 \cdot IMSBTR + a2 \cdot \frac{VOL^{1/3}}{IMSL} + a3 \cdot \frac{SA \cdot HA}{IMSB^3} + a4 \cdot \frac{IMSB}{VOL^{1/3}} \right) \cdot DSPM \cdot IMSL \quad (4.33)$$

where all the variables are calculated by the VPP using the following coefficient values.

a0	=	-0.00410481856369339 (regression coefficient)
a1	=	-0.0000399900056441 (regression coefficient)
a2	=	-0.0001700878169134 (regression coefficient)
a3	=	0.00001918314177143 (regression coefficient)
a4	=	0.00360273975568493 (regression coefficient)
DSPM	=	displacement in sailing trim
SA	=	sail area upwind
HA	=	heeling arm, defined as

$$\frac{CEH_{main} \cdot A_{main} + CEH_{headsail} \cdot A_{headsail} + CEH_{mizzen} \cdot A_{mizzen}}{SA} + HBI + DHKA \cdot 0.45$$

CEH	=	height of centre of effort
DHKA	=	Draft of keel and hull adjusted

Such predicted $RM@1_{default}$ shall not be taken less than one giving the Limit of positive stability (LPS) of 103.0 degrees or 90.0 degrees for an ORC Sportboat.

5 AERODYNAMIC FORCES

The VPP assumes that each individual sail, mainsail, jib, spinnaker, gennaker or code zero can be characterized by a maximum achievable lift coefficient and a corresponding viscous drag coefficient that are continuous functions of apparent wind angle. The values of these coefficients are adjusted depending on the exact sail type and the mast and rigging configuration. The individual coefficients are then combined into a set of complete sail plan (main and jib, or main and spinnaker) coefficients.

In order to simulate the reduction of heeling force by the crew trimming and changing sails *Flat* and *Reef* parameters are used.

The flat parameter is used to simulate the reduction of the lift coefficient. It reduces from a value of 1.0, associated with maximum lift, to a minimum value of 0.42 for normally rigged yachts¹, i.e. the lift coefficient reduced by 58%.

The reef parameter simulates the reduction of sail area. When reefing is required to achieve optimum performance the genoa sail area is first reduced until the genoa reaches its minimum foot length, then if further heeling force reduction is required the mainsail is reefed.

The VPP optimizer is at liberty to de-power the sails by reducing the maximum lift coefficient (*Flat*) and reduce sail size (*Reef*) to achieve best performance at each prescribed true wind angle and velocity.

5.1 METHODOLOGY

The aerodynamic forces acting on the yacht are resolved into two orthogonal components, lift and drag. The lift force acts perpendicular to the apparent wind direction and the drag force acts parallel to it. The force model incorporates 3 sources of drag:

1. The base drag associated with the windage of the hull, spars, rigging and crew;
2. The parasitic drag associated with the skin friction drag of the sails, and the pressure drag associated with flow separation. The parasitic drag is assumed not to depend on the sail lift force, it does however vary with the point of sailing;
3. The induced drag, which arises from the three-dimensional nature of the flow around the sails, and the loss of circulation from the head and foot of the sails. The induced drag is assumed to vary as the square of the lift coefficient. A two-dimensional lift dependant drag term is also added to the basic induced drag.

Analysis of the rig begins by ascribing the appropriate coefficient set to the main, jib and offwind sails. The frontal and side areas associated with the mast, hull and rigging are also calculated. Each area has an associated vertical centre of force which represents the height at which all the aerodynamic loads could be concentrated to produce the same overall rolling moment. Because the presence of a wind gradient implies that the wind velocity is a function of height, the vertical heights of the centres of force are used when evaluating the dynamic pressure acting on any aerodynamic surface.

5.1.1 INDIVIDUAL SAIL AREAS AND 2-DIMENSIONAL AERODYNAMIC FORCE COEFFICIENTS

The fundamental components of the aerodynamic model are the individual sails, characterised by the following parameters, which are shown diagrammatically in Figure 5.1:

- Sail area
- Centre of effort height above the sail's datum
- CL_{max} and CD_0 versus β_{AW} envelope. (Maximum lift coefficient and parasitic (viscous) drag coefficient versus apparent wind angle).

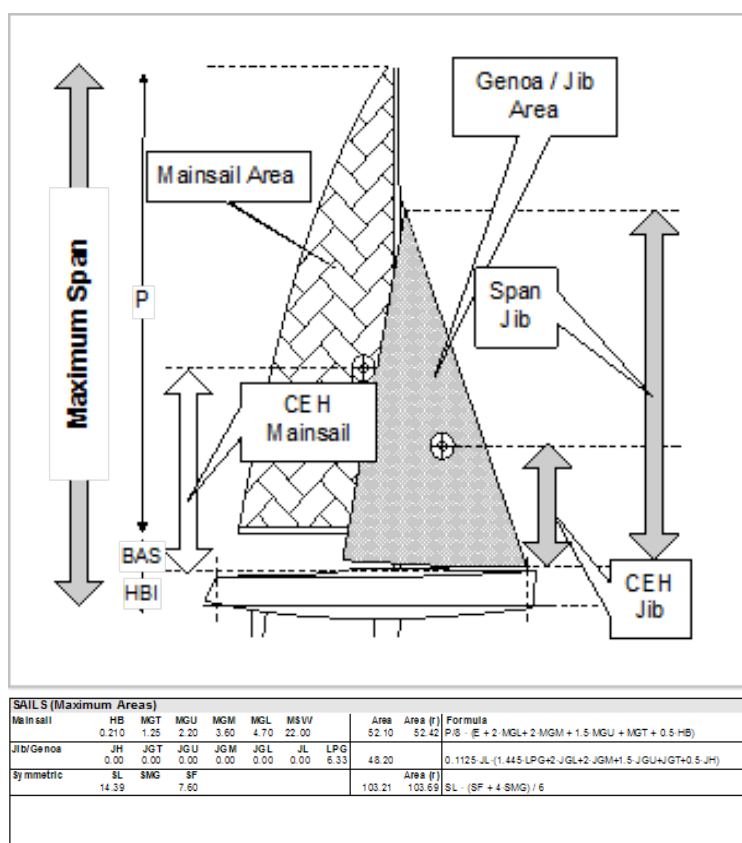

FIGURE 5.1: Sail parameters

Figure 5.2 shows the individual two-dimensional coefficients for the 3 sail types originally supported by the VPP. The characteristics of the mainsail and jib and spinnaker were derived empirically when the sail force model was introduced². The coefficient values, which are based on cloth area, show typical effects:

- As apparent wind angle increases a rapid rise in lift to a peak value prior to the onset of separation and stall.
- The sails ‘fill’ at different apparent wind angles, reflecting the different sheeting arrangements and shapes of the sails.
- At an apparent wind angle of 180 degrees, approximating to an angle of attack of 90 degrees, the lift has declined to zero and the drag coefficient increased to 1.0.

5.1.2 SIMPLIFIED RIGGING COEFFICIENTS

This reflects the ability of yachts with more complex fore and aft staying arrangements to adjust their sails for best performance. The Mainsail and Jib may have varying lift and drag force coefficients depending on the ability to change the camber of the sails by adjustable stays.

For both sail types a low and a high set of lift and drag coefficients exist. In the application of the coefficients adjustable forestays, backstays, and running backstays are considered. The details of the scheme are described in sections 5.2.1 for the mainsail and 5.2.2 for the jib.

Since 2026 the RS assesment has been introduced, proposing an alternative method of taking into account a number of features of the rig and sails, that may be using also non manual power. In that context, the rig features producing the performance increase from “low” to “high” set of coefficients have been included. Therefore since 2026 the set used

¹This minimum flat value of 0.42 is based on the lift force reduction that has been observed in wind tunnel tests

²The aerodynamic coefficients of the sails have been adjusted and modified a number of times in order to follow the sail performance development. Furthermore, while in the old days some *efficiency* factors were adopted for the sails areas (1/1.16 for the mainsail, 0.6 for the symmetric spinnaker, 0.72 for the asymmetric), more recently this approach has been abandoned and the aero coefficients are based on the rated sail areas, which are close to the geometric sail areas. The last adjustment to the coefficients of single sails was done in 2016.

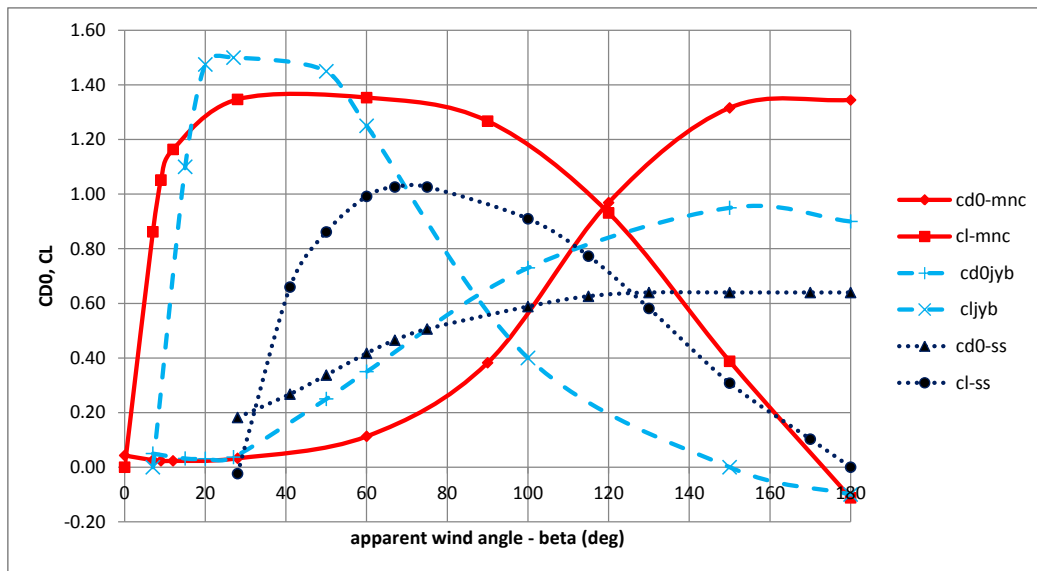

FIGURE 5.2: Basic Sail Force Coefficients

RIG	RS	SAILS	RS
Inner stay fixed	0.025	Vang NMP	0.051
Inner stay adjustable	0.051	Outhaul NMP	0.025
Inner stay adjustable NMP	0.076	Halyards NMP	0.051
Forestay adjustable turnbuckle	0.051	Main cunningham NMP	0.025
Forestay adjustable	0.127	Headsail cunningham NMP	0.051
Forestay adjustable NMP	0.203	Traveller NMP	0.102
Backstay adjustable	0.127	Sheets NMP	0.102
Backstay adjustable NMP	0.203	Tack line NMP	0.051
Running backstay adjustable	0.127	Headsail track NMP	0.051
Running backstay adjustable NMP	0.203	Spinnaker retriever	0.051
Checkstays adjustable	0.076	Spinnaker retriever NMP	0.102
Checkstays adjustable NMP	0.102		
Base of the mast adjustable	0.051		
Base of the mast adjustable NMP	0.102		

TABLE 5.1: RS percentages for various rig and sails features

for the VPP solution is the "low" one, then after the VPP solution has been determined, the RS assesment is applied as a percentage increase to the predicted speed.

RS rating assesment is composed by a number of items, each one having its weight. The total allowance does not exceeds 1.5%, and is detailed in table 5.1.

5.1.3 OPTIMIZATION AND DE-POWERING

REVISED OPTIMIZATION SCHEME

Traditionally (up to 2009) the VPP aerodynamic model has been free to adjust the sail power (Flat) and area (Reef) independently to achieve the highest sailing speed at each True Wind Angle. Then a different scheme was devised, where the jib was reduced to a minimum area only after the sails have been fully flattened. After reaching the minimum jib area, the mainsail was reduced. This scheme was good and reflected very well the behaviour of the boat sailing upwind. When reching the picture changes slightly, because the large heeling moments often need a larger reduction of the center of effort height, which is easily accomplished by some amount of sail area reduction. Also, the introduction of the solution at TWS=24 knots complicated even more the scenario. A revised scheme (2024) allows the depowering by *reef* and *flat* in parallel, yet keeping almost unchanged the reefing sequence devised, with first a

reduction of the jib foot and jib area to a minimum, and then a simultaneous reduction of the mainsail and jib areas.

DE-POWERING WITH JIB

The sail trimming scheme adopts the following methodology to reduce sail area as wind speed increases.

1. Reduce jib area progressively to the minimum jib area.
2. Once the Minimum jib area is reached reduce mainsail area and jib area together.

In parallel to this area reduction, the *flat* parameter can be adjusted down to $Flat_{MIN} = 0.53 \times Flat_8^3$. $Flat_8$ is the *flat* value used with jib upwind at TWS=8 kt and TWA=52 degrees. This remodulation of the minimum is done with the aim of giving the same amount of relative *flat* reduction even for boats using a certain amount of depowering already in light winds.

The de-powering scheme is based on new VPP variables *ftj*, and *rfm* working with a new⁴ optimization parameter RED that replaces the traditional *reef* parameter.

ftj = jib foot parameter *ftj*=1 full size jib, *ftj*=0 minimum jib
rfm = is the main+minjib reduction factor, *Rfm*=1 full main+minjib, *rfm*=0 no main+minjib.

RED is a combination of these 2 factors into a single optimization parameter.

RED = 2 then *ftj*=*rfm*=1, i.e. full sail
 RED = 1 then *ftj*=0, *rfm*=1, i.e. jib at minimum size
 RED < 1 then *ftj*=0 and *rfm*<1.

The usual *reef* parameter, comparing in the output of the VPP, when the headsail is a jib or genoa it has to be read as a re-parametrization of the RED parameter, by means the simple relation $reef = RED/2$. The progressive de-powering scheme is shown graphically in Figure 5.3. At each stage in the process the current sail area, fractionality and overlap are calculated and the values used to calculate the Effective rig height and vertical centre of pressure position.

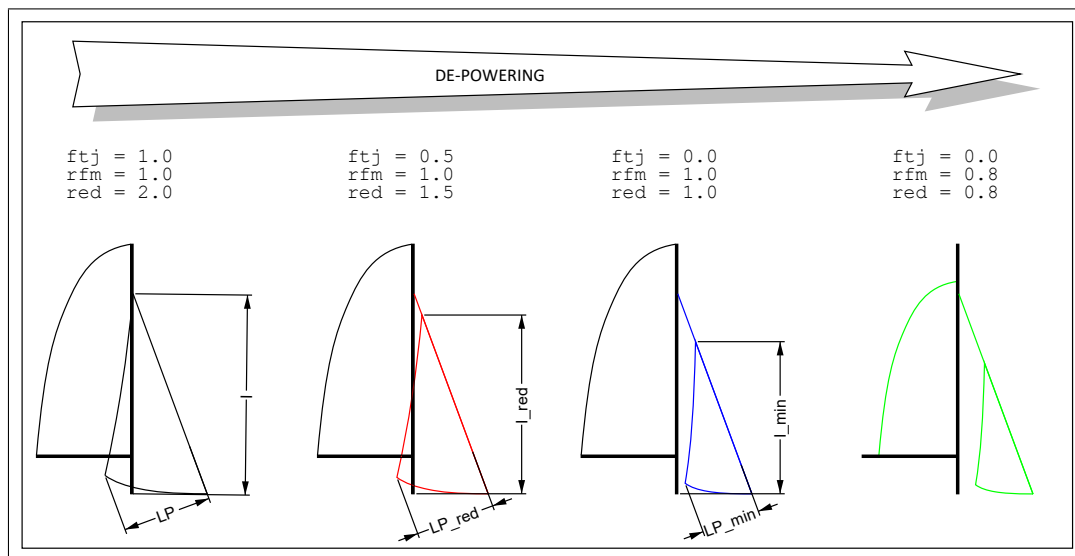

FIGURE 5.3: De-powering scheme

The total sail forces are now calculated during each VPP iteration⁵. The process is described in Figure 5.4.

³The baseline minimum flat has been changed to 0.53 in 2024

⁴2010

⁵rather than adopting the *RIGANAL* approach of the old code where as much of the aero model as possible was pre-calculated before the VPP itself was run. The current approach would not have been possible even 10 years ago due to the extra burden of calculation making the VPP too slow to run routinely.

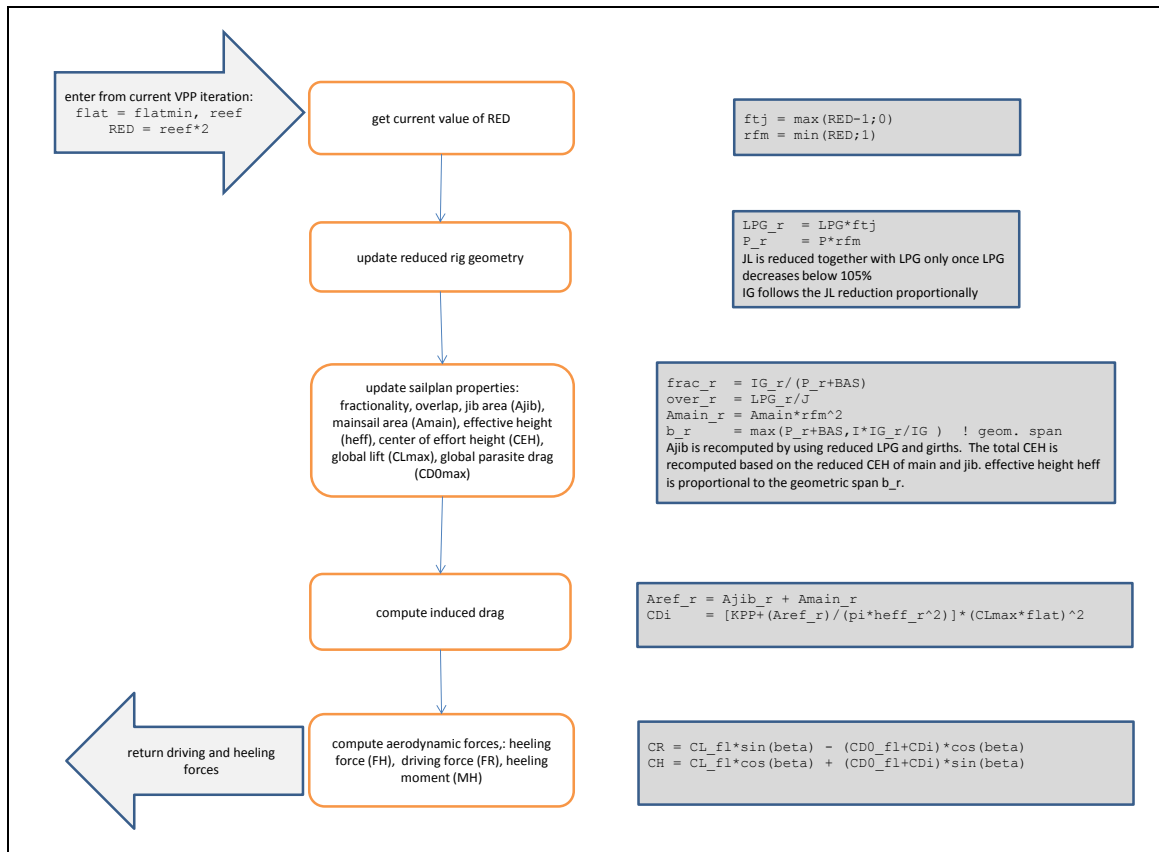

FIGURE 5.4: Routine for de-powering

DE-POWERING WITH SPINNAKER AND HEADSAIL SET FLYING

With headsails different from the jib, the depowering scheme is simpler: the *flat* and *reef* parameters act together, and the global sail area is reduced as $A \cdot reef^2$, while the center of effort height decreases as $Z_{CE} = Z_{CE} \cdot reef$. The depowering is limited to higher values of *reef*: $0.85 \cdot Default_Area_Spin / Area_Spin$ for spinnakers, 0.91 for headsail set flying. The flat limit is kept at $flatmin = 0.53$. The above boundaries reflect the more limited possibility of depowering with those sails, and also the fact that with headsail set flying all the sails in the inventory are run by the VPP, therefore there is no more need of a heavy reefing modelling the change of sail to a smaller one. For spinnakers, the reference value of 0.85 is multiplied by the ratio of the default spin area based on the foretriangle size to the largest spinnaker area. This accounts for letting the VPP depower more heavily for boats carrying large spinnakers, that supposedly will be replaced by smaller ones as the windspeed increases.

5.2 SAIL AREAS & COEFFICIENTS

5.2.1 MAINSAIL

MAINSAIL AREA AND ROACH

Mainsail area is the physical cloth area of the largest mainsail in the yacht's sail inventory⁶.

In 2010 a revised scheme for determining the height of the girth sections was adopted. The heights are calculated

⁶Before 2010 the area was calculated as follows: $Area_Main = \frac{P}{8} \cdot (E + 2MQW + 2MHW + 1.5MTW + MUW + 0.5MHB)$ Presently this formula is still used, due to its simplicity, by the ORC Manager for what is called the *measured* area, written also on the certificate

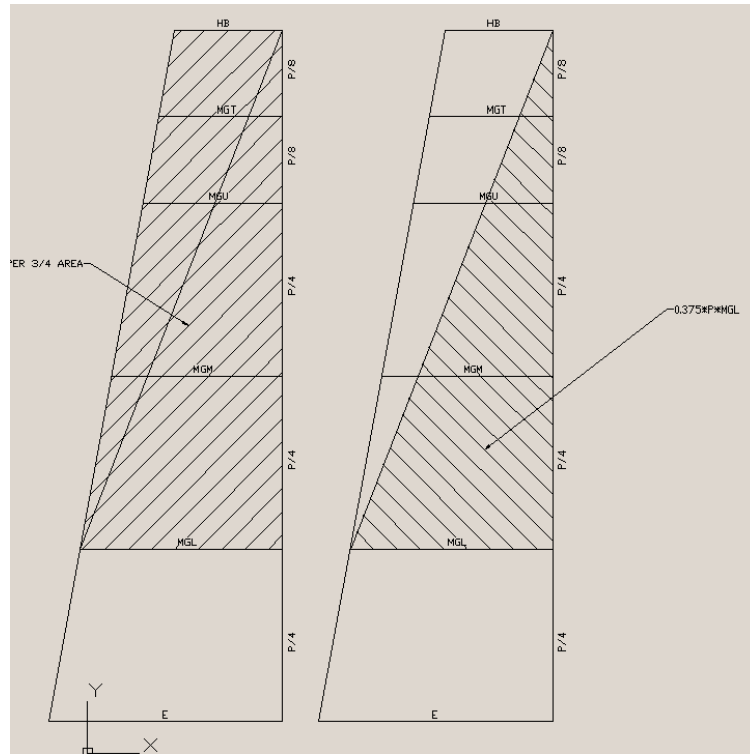

FIGURE 5.5: Roach calculation

using the following formula which must be calculated in the order presented.

$$\begin{aligned}
 MWH &= \frac{P}{2} + \frac{MHW - E/2}{P} \cdot E \\
 MQWH &= \frac{MWH}{2} + \frac{MQW - (E + MHW)/2}{MWH} \cdot (E - MHW) \\
 MTWH &= \frac{MWH + P}{2} + \frac{MTW - MHW/2}{P - MWH} \cdot MHW \\
 MUWH &= \frac{MTWH + P}{2} + \frac{MUW - MTW/2}{P - MTWH} \cdot MTW
 \end{aligned} \tag{5.1}$$

Mainsail rated area is then calculated as follows:

$$\begin{aligned}
 Area &= \frac{MQW + E}{2} \cdot MQWH + \frac{MQW + MHW}{2} \cdot (MWH - MQWH) + \\
 &\quad \frac{MHW + MTW}{2} \cdot (MTWH - MWH) + \frac{MUW + MTW}{2} \cdot (MUWH - MTWH) + \\
 &\quad \frac{MUW + MHB}{2} \cdot (P - MUWH)
 \end{aligned} \tag{5.2}$$

The boom depth (BD) limit is $0.06 \cdot E$. If BD exceeds its limit, mainsail area shall be increased by $2 \cdot E \cdot (BD - 0.06 \cdot E)$. If the mast is recorded as rotating, the mast side area is added to the mainsail area. The amount of roach will proportionally increase the rated area from the measured one. A parameter *roach* is calculated to define the planform shape of the mainsail:

$$ROACH = \frac{\frac{upper_3/4_area}{0.375 \cdot P \cdot MQW} - 1}{0.844} \tag{5.3}$$

The roach is calculated in the upper 3/4 part of the mainsail to avoid any influence of E (that is not measured on the sail). The upper 3/4 area of the mainsail is calculated as follows:

$$Upper_3/4_area = \frac{P}{8} \cdot (MQW + 2MHW + 1.5MTW + MUW + 0.5MHB) \tag{5.4}$$

A roach value of zero corresponds to a main with triangular 3/4 upper part. Negative roaches are accounted as zero. A value greater than this indicates a degree of “big headedness”⁷. The constant 0.844 is introduced to normalize the roach measurement with the roach measured in wind tunnel based on $P \cdot E/2$ triangle.

MAINSAIL COEFFICIENTS

The mainsail may have either of two coefficient sets as shown in Table 5.2, the standard mainsail and one based on having no adjustable check stays. The “simple” main without checkstays is characterized by a reduced maximum available Lift Coefficient resulting from the inability to increase sail camber in light airs through the use of check stays, as shown in Figure 5.6 .

Nomenclature:

- kpm = two dimensional quadratic viscous drag coefficient
- beta = Apparent wind angle (deg)
- CD = Drag Coefficient
- CL = Lift Coefficient

MAINSAIL										
kpm	0.01379									
β	0	7	9	12	28	60	90	120	150	180
cdnc- CD_{low}	0.04310	0.02586	0.02328	0.02328	0.03259	0.11302	0.38250	0.96888	1.31578	1.34483
clnc- CL_{low}	0.00000	0.86207	1.05172	1.16379	1.34698	1.35345	1.26724	0.93103	0.38793	-0.11207
cdyc- CD_{hi}	0.03448	0.01724	0.01466	0.01466	0.02586	0.11302	0.38250	0.96888	1.31578	1.34483
clyc- CL_{hi}	0.00000	0.94828	1.13793	1.25000	1.42681	1.38319	1.26724	0.93103	0.38793	-0.11207

TABLE 5.2: Mainsail force coefficients

The low set of lift and drag coefficients (CL_{low}) is used when there is neither a backstay nor a pair of running backstays or in case of one pair of running backstays only. With two or more backstays (regardless of type) the high set of coefficients (CL_{high}) is applied. Table 5.3 shows the matrix of rated rigging arrangements and corresponding

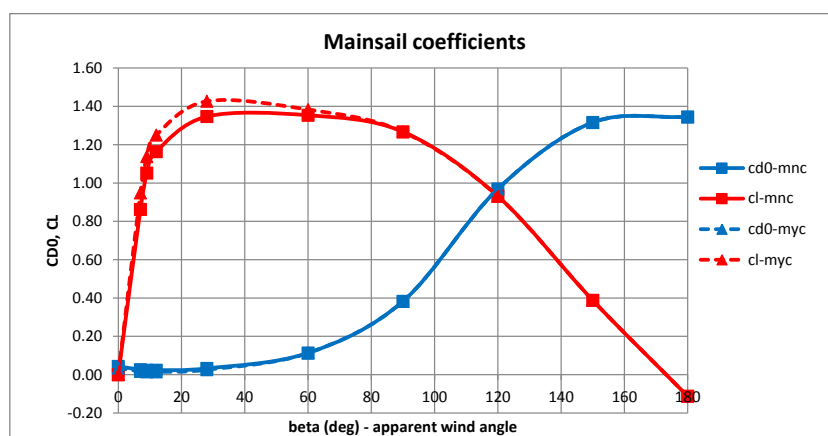

FIGURE 5.6: Alternative Mainsail force coefficients

main sail force coefficient sets.

- L = Low Lift associated with low mainsail adjustability.
- H = High Lift associated with increased mast bend control.
- M = intermediate coefficient set depending on rig fractionality.

⁷2013

Mainsail Coefficients				
BACKSTAY	FORESTAY			
	fixed	adj fwd	adj aft	adj aft&fwd
None	L	L	error (M)	error (M)
Backstay only	L	L	M	M
Running Backstay only	warning (L)	warning (L)	L	L
2 or more Backstays and/or adjustable inner forestay	H	H	H	H

$L = C_{low}$
 $M = C_{moderate} = C_{low} \cdot (1 - Coef/2) + C_{high_new} \cdot Coef/2$
 $H = C_{high_new} = (C_{low} + C_{high_old}) / 2$

TABLE 5.3: Application of Alternative Coefficient sets for Mainsails

In the case of a backstay being fitted but without running backstays, a fractionality coefficient f_{Coef} is derived which controls the effect of the backstay on the mainsail shape. This is shown diagrammatically in Figure 5.7.

$$f_{coef} = \sqrt{\sin \left[\frac{\pi}{0.6} \cdot \min \left(0.3; \max \left(0; \frac{1}{Fractionality} - 1 \right) \right) \right]} \quad (5.5)$$

For the configuration with one pair of backstays only, a medium level set of coefficients is calculated:

$$C_{medium} = C_{low} \cdot \left(1 - \frac{f_{coef}}{2} \right) + C_{high} \cdot \frac{f_{coef}}{2} \quad (5.6)$$

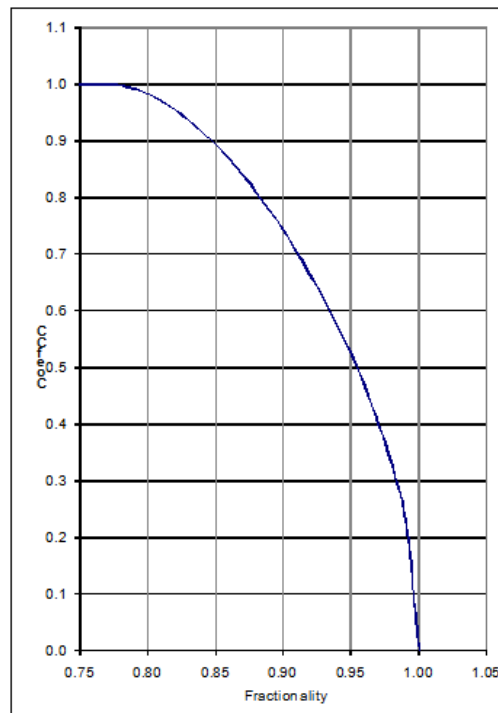

FIGURE 5.7: Fractionality Coefficient

MAST SHADOW EFFECT

In 2016 it has been introduced (better, re-introduced, because the very same effect was modeled by ITC experts many years ago) a model taking into account the shadow effect of the mast portion above the hounds on the mainsail. The effect is taken into account by calculating the portion of mainsail that is included in a strip wide 1.5 the average mast diameter $0.5(MDL + MDT)$ calculated at that height. That portion of area is subtracted to the mainsail area.

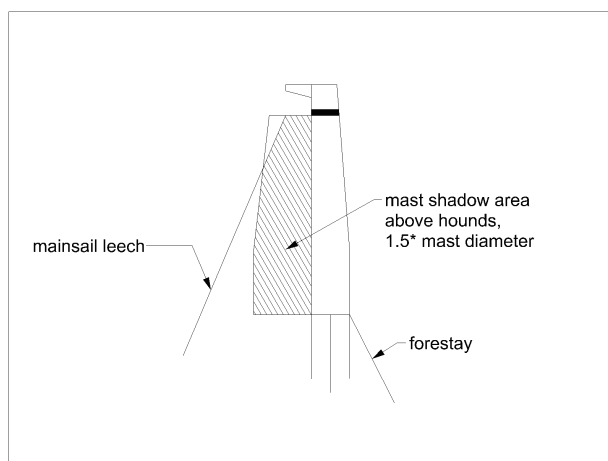

FIGURE 5.8: shadow effect of the mast portion above the hounds

LOW TECHNOLOGY SAIL CLOTH

When the sails are made of low technology material, as woven polyester sail cloth, a credit is applied to the mainsail coefficients, by slightly modifying both drag and lift coefficients by the following amounts: The credit has

β	0	7	9	12	28	60	90	120	150	180
dcd	0.0028	0.0028	0.0028	0.0028	0.0028	0.0	0.0	0.0	0.0	0.0
dcl	0.0000	0.0284	0.0284	0.0284	0.0284	0.0085	0.0	0.0	0.0	0.0

TABLE 5.4: Mainsail low tech material credit

been reduced in 2016 to 33% of the 2015 credit.

CENTRE OF EFFORT (CE) CALCULATION

The mainsail centre of effort is calculated as the centroid of area of the projected mainsail trapezoid areas, plus a constant, that is $0.024 \cdot P$.

$$CEH = \frac{\sum_i A_i \cdot zc_i}{\sum_i A_i} + 0.024 \cdot P \quad (5.7)$$

where A_i are the areas of trapezoids formed by the girths, portion of the luff and portion of the leech, and zc_i is the height above the P base of the centroid of each trapezoid. The constant was chosen in the past, when it was introduced the formulation based on trapezes areas, in order to maintain, for a mainsail with default girths, the value of $CEH = 0.39P$, that was used before. Since 2011 the default girths were modified, so that with the present defaults we have $CEH = 0.40 \cdot P$.

5.2.2 JIB OR GENOA

The jib also has 2 possible coefficient sets depending on whether the forestay can be adjusted whilst racing. If it can be adjusted the jib has a higher maximum Lift Coefficient to reflect the fact that sail camber can be increased in light airs by easing the head stay.

GENOA AREA

Jib rated area is be the biggest area of any jib/genoa in the sail inventory calculated as follows:

$$Jib_area = 0.1125HLU(1.445HLP + 2HQW + 2HHW + 1.5HTW + HUW + 0.5HHB) \quad (5.8)$$

using the girths measured as per the ERS (ERS 2016). The above formula is the area of a genoa where the portion above the HLP is divided into trapezes bounded by the girths and by portions of leech and luff, while the portion below the HLP is estimated as a triangle, where the sides are the HLP , the foot, and a portion of the luff, equal to $0.1 \cdot HLU$.

Since 2022 the minimum size of the jib (*default jib*) has been eliminated, a boat may carry only a mainsail and does not have any penalty in sail area for this arrangement.

GENOA AERODYNAMIC COEFFICIENTS

A similar approach to the mainsail is applied for the set of lift and drag coefficients of the jib, as shown in Table 5.5. The low set of coefficients is applied only when there is neither a backstay nor an adjustable forestay. If the forestay is adjustable or in the case of one or more pairs of running backstays the high set of coefficients is used. The coefficients are plotted in Figure 5.9.

JIB									
kpj	0.016								
β	7	15	20	27	50	60	100	150	180
cdjnb- CD_{low}	0.05000	0.03200	0.03100	0.03700	0.25000	0.35000	0.73000	0.95000	0.90000
cljnb- CL_{low}	0.00000	1.00000	1.37500	1.45000	1.45000	1.25000	0.40000	0.00000	-0.10000
cdjyb- CD_{hi}	0.05000	0.03200	0.03100	0.03700	0.25000	0.35000	0.73000	0.95000	0.90000
cljyb- CL_{hi}	0.00000	1.10000	1.47500	1.50000	1.45000	1.25000	0.40000	0.00000	-0.10000

TABLE 5.5: Genoa Force Coefficients

There is no difference in the coefficients for jibs and genoa with or without battens.

Headsail Coefficients				
BACKSTAY	FORESTAY			
	fixed	adj fwd	adj aft	adj aft&fwd
None	L	H	error (M)	error (H)
Backstay only	L	H	M	H
Running Backstay only	warning (H)	warning (H)	H	H
2 or more Backstays	H	H	H	H

$L = C_{low}$
 $M = C_{moderate} = C_{low} \cdot Coeff + C_{high} \cdot (1 - Coef)$
 $H = C_{high}$

TABLE 5.6: Application of Alternative sets for jibs

Table 4 shows the matrix of rated rigging arrangements and corresponding jib/genoa sail force coefficient sets.

- L = Low Lift associated with a non adjustable forestay which does not allow genoa camber to be controlled.
H = High Lift associated with increased forestay control.

In case of a backstay being fitted but no running backstays, a medium level set of coefficients is calculated similar to the procedure applied for the mainsail. The intermediate coefficients are derived with the same fractionality coefficient f_{Coef} given above by using the following formula:

$$C_{medium} = C_{low} \cdot f_{coef} + C_{high} \cdot (1 - f_{coef}) \quad (5.9)$$

ROLLER FURLING GENOA

For a roller furling genoa the lift coefficient is reduced by the amount ΔCl at each apparent wind angle, as reported in table 5.7. The parasitic drag coefficient is increased proportionally to the overlap reduction of the sail:

$$\Delta Cd0 = \Delta Cd0_{max} \cdot \frac{over0 - over_r}{0.6} \quad (5.10)$$

where $over_r$ is the actual overlap of the reduced sail, and $over0$ is the overlap of the full size sail.

LOW TECHNOLOGY SAIL CLOTH

As for the mainsail, also for the jib a credit for carrying only jibs made by low technology material is available. Its value has been reduced in 2016 to 33% of 2015, and it's equal to 33% of the Roller furling jib credit of par.(5.2.2).

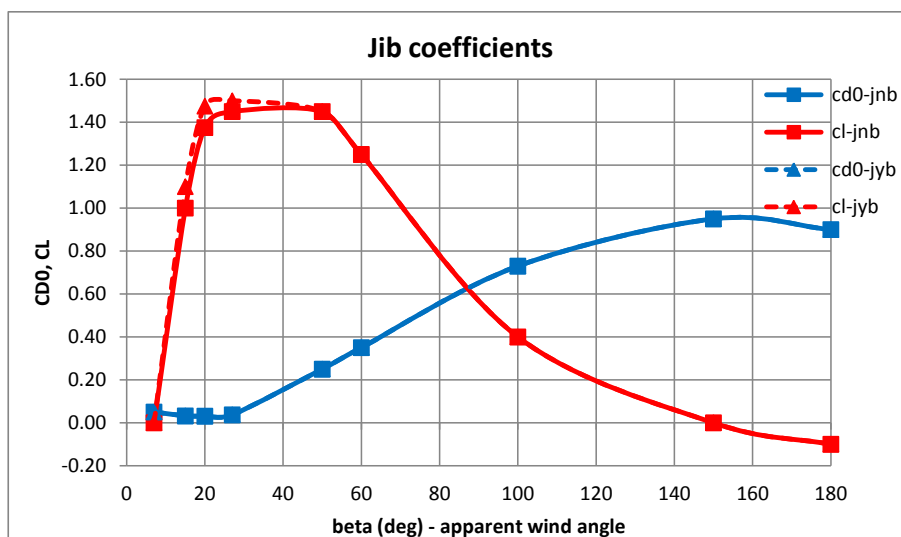

FIGURE 5.9: Alternative Jib Force Coefficient

AWA	7.0	15.0	20.0	27.0	50.0	60.0	100.0	150.0	180.0
ΔCl	0.0	0.10	0.10	0.05	0.00	0.00	0.0	0.0	0.0
$\Delta Cd_{0_{max}}$	0.006	0.006	0.006	0.006	0.0051	0.0	0.0	0.0	0.0

TABLE 5.7: Change in aerodynamic lift and drag coefficients for roller furling jib.

JIB WITH WHISKER POLE

In 2022 the whisker pole effect on a jib has been modelled: when a boat makes use of the whisker pole (which has to be declared as WPL , and for being considered to be used leeward has to be $WPL < 0.9J$; otherwise it's considered a pole to be used to windward), the reaching performances with jib are computed using the aerodynamic coefficients equal to those of an headsail set flying of size equal to the maximum jib.

NO SPINNAKER CONFIGURATION

For the “No Spinnaker” configuration the yacht is run through the VPP with the normal jib force coefficients. Also a sail set called “jib downwind” between True Wind Angles of 60° and 180° using the asymmetric on centerline or asymmetric on pole coefficients, depending if there is a pole on board ($SPL > 0$ or $WPL > 0.9J$), and a sail area equal to 1.064 times the jib area. For handicapping the best speed from each of the polar curves is selected.

JIB CENTRE OF EFFORT (CE) CALCULATION

The jib centre of effort is calculated as the centroid of area of the projected trapezoid areas, plus the triangular portion below the LPG .

$$CEH = \frac{\sum_i A_i \cdot z_{Ci}}{\sum_i A_i} \quad (5.11)$$

5.2.3 SPINNAKERS

The following configurations can be handicapped:

1. No spinnaker
2. Symmetric spinnaker on pole only
3. Asymmetric spinnaker tacked on CL
4. Asymmetric spinnaker on pole , asymmetric on CL and symmetric on pole

SPINNAKER AREA

The spinnaker area taken into account by the VPP is the one of the largest spinnaker on board. Beside that area, any spinnaker having a ratio $SHW/SFL < 0.85$ is run by the VPP using the coefficients defined in 5.2.5. The area is computed as

$$Spinnaker_area = \frac{SL \cdot (SFL + 4 \cdot SHW)}{6} \quad (5.12)$$

For asymmetric spinnakers $SL = (SLU + SLE)/2$.

A default spinnaker area is calculated. From 2011 onwards if the measured area is less than the default area the default spinnaker area is used in the VPP calculation. Default values for symmetric spinnakers:

$$SL_{default} = 0.95 \cdot \sqrt{ISP^2 + J^2} \quad (5.13)$$

$$SFL_{default} = 1.8 \cdot \max(SPL, J) \quad (5.14)$$

$$SHW_{default} = 0.75 \cdot SFL_{default} \quad (5.15)$$

If SPL is not recorded it will be set $SPL = J$

For the asymmetric spinnaker:

$$SL_{default} = 0.95 \cdot \sqrt{ISP^2 + J^2} \quad (5.16)$$

$$SFL_{default} = \max(1.8 \cdot SPL, 1.8 \cdot J, 1.6 \cdot TPS) \quad (5.17)$$

$$SHW_{default} = 0.75 \cdot SFL_{default} \quad (5.18)$$

In the case that the configuration is only asymmetric on CL and TPS is not recorded it will be set $TPS = J$.

If there is no spinnaker aboard the boat will be rated as explained above in 5.2.2.

FORCE COEFFICIENTS (2011, 2016, 2022)

kpsc	0.02639											
β	28	41	50	60	67	75	100	115	130	150	170	180
cdss1	0.18194	0.26744	0.33721	0.41724	0.47100	0.51100	0.58824	0.63200	0.66200	0.70200	0.65500	0.63500
clss1	-0.02360	0.65965	0.86143	0.99180	1.01300	1.00000	0.92500	0.82700	0.67300	0.39100	0.11500	0.00000

TABLE 5.8: Symmetric Spinnaker Force Coefficients

kpasc	0.02648											
β	28	41	50	60	67	75	100	115	130	150	170	180
cdasc1	0.15405	0.23500	0.28500	0.33500	0.36500	0.40000	0.51500	0.56500	0.54000	0.42000	0.22800	0.19500
clasc1	0.01738	0.69825	0.92000	1.08000	1.12500	1.13000	1.03500	0.88500	0.59200	0.24000	0.03900	0.00000

TABLE 5.9: Asymmetric Spinnaker tacked on centreline Force Coefficients

kpasp	0.02648											
β	28	41	50	60	67	75	100	115	130	150	170	180
cdasp1	0.15405	0.23500	0.28500	0.33500	0.36500	0.40000	0.51500	0.59000	0.68000	0.70200	0.65500	0.63500
clasp1	0.01738	0.69825	0.92000	1.08000	1.12500	1.13000	1.03500	0.95000	0.71000	0.39100	0.11500	0.00000

TABLE 5.10: Asymmetric Spinnaker tacked on a pole Force Coefficients

The Spinnaker Coefficients are plotted in Figure 5.10.

REDUCTION IN DRIVE FORCE FROM LARGE SPINNAKERS IN LIGHT AIRS (SHAPE FUNCTION)

The SHAPE function⁸ was introduced some years ago as it is an observed effect that large spinnakers are particularly inefficient in light airs. To address this “type-forming” towards smaller spinnakers, a power loss factor for larger sails was developed so reducing the effective area of a spinnaker that is bigger than the “reference area”. The current

⁸2011 & 2012

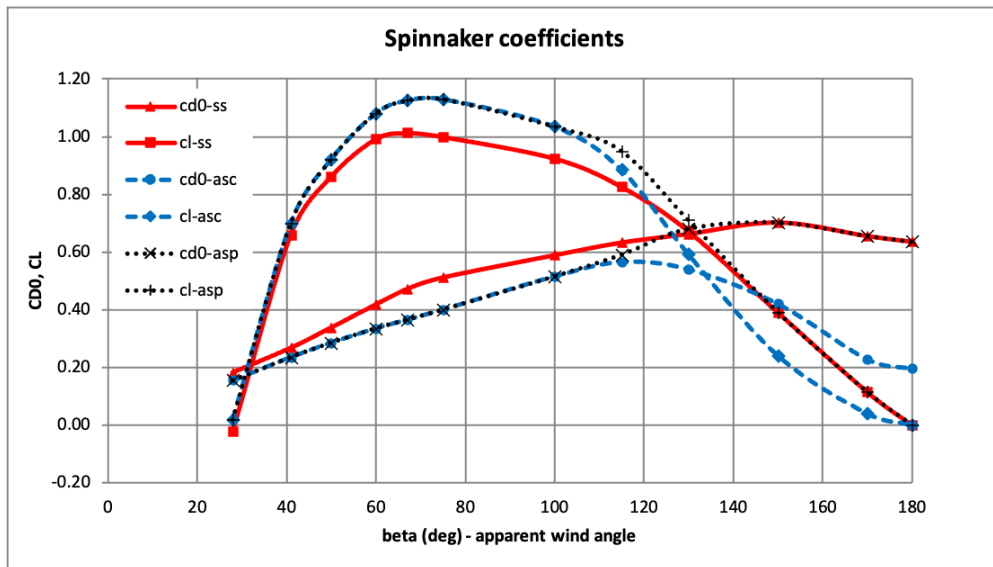

FIGURE 5.10: Symmetric, Asymmetric on CL and Asymmetric on Pole Spinnaker Coefficients

formulation was adopted in 2012 and it considers the space available for the spinnaker to be flown in, defined by ISPC, J and pole type.

Features of the shape function:

- The reference area depends on whether a pole or a bowsprit configuration is used, due to the different space available in each case;
- The shape function reference area has a *head angle* relationship as well as being related to ISP and TPS in order to bring in the effect of gravity making it harder to fly a lower aspect ratio sail;
- The shape function relates to apparent wind speed rather than true;
- The ISP used by the reference area is the full ISP for pole boats at $AWA < 80^\circ$, blending to ISPC at $AWA > 90^\circ$, in order to simulate the practice of tacking very light wind sails onto a short bowsprit length to gain more projected area. ISP for sprit boats is the full ISP throughout the range of AWA.

This is the SHAPE function formulation:

$$\begin{aligned}
 SHAPE &= 1 + Wind_Speed_Range_Multiplier * (Shape_factor - 1) \\
 Wind_Speed_range_Multiplier &= 1 \text{ if } AWS < 5, \quad 0 \text{ if } AWS > 6 \\
 &\text{(the Multiplier} = 1 \text{ for } AWS < 5, \quad 0 \text{ for } AWS > 6, \quad (5.19) \\
 &\text{and interpolates between)}
 \end{aligned}$$

$$\begin{aligned}
 Shape_factor &= 1 - 3 \cdot (Ref_Area/Area_actual - 1)^2 \quad \text{with } 0.8 < Shape_factor < 1.0 \\
 Area_actual &= \max(SPI_AREA, Ref_Area) \\
 Ref_Area &= 1.04625 \cdot ISPC \cdot SPLc / Head_Angle_Corrector \\
 Head_Angle_Corrector &= \arctan(2.5 \cdot (SPL; TPS) / ISPC) \quad (5.20)
 \end{aligned}$$

$$\begin{aligned}
 ISPC &= ISP \text{ (for sprit) or } ISP - 0.16 \cdot LSM1 \text{ (for poles)} \\
 &\quad (5.21)
 \end{aligned}$$

The formulation ensures that the “rated area” increases slightly with the increase of TPS, even in 5 kts AWS, and the reference area is more appropriate to a small sail for the limited space and AWA. Being related to AWS, it is physically realistic and should mean that for a light boat the effect disappears at about 10kts TWS, while for a 37’ heavy cruiser-racer the effect tapers down at 12 kts TWS with the transition represented in Figure 5.11. For spinnaker area below default area, no further reductions will be made, while the maximum reduction will be limited to 75% of measured area.

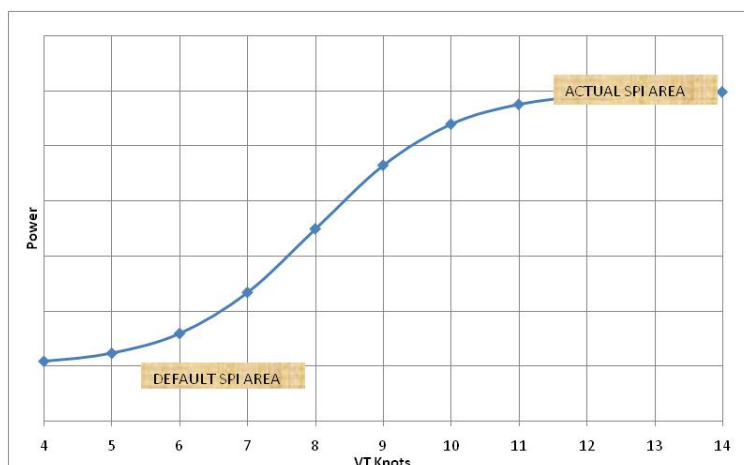

FIGURE 5.11: Large Spinnakers Force Correction in light winds

SPINNAKER CENTRE OF EFFORT HEIGHT

The centre of effort height is $0.565 \cdot ISP$ above the base of I .

SPINNAKER JIB CROSSOVER (2011, 2016)

The 2011 and 2016 modifications to the spinnaker coefficients were largely driven by the desire to “force” the VPP to adopt crossover points from spinnaker to jib at apparent wind angles that more closely reflect the angles observed whilst sailing.

Moreover, in 2014 the maximum heel angle allowed under spinnaker was reduced from about 26.5 to about 21.5 degrees. Numbers are approximated because when approaching the limit value a ‘soft’ boundary is modeled in terms of a rapidly increasing resistance. The minimum REEF factor allowed was fixed at: $0.85 \cdot Default_Spin_Area / Spin_Area$.

5.2.4 SPINNAKER TACK POSITION *Power* FUNCTION

In order to more equitably handicap the influence of increasing the length of the spinnaker pole or bowsprit relative to the spinnaker, gennaker and Code zero mid-girth a *power* function was introduced to the mainsail blanketing algorithm as shown in the equation below.

The power calculation is triggered by the value of the term f_{sp} . If this is less than 0.0 then the spinnaker pole is considered longer than the norm and the power function increases above 1.0.

The Power Function since 2013 has an apparent wind angle linkage, so that the effective reference area is essentially similar to what would be ideal for the wind angle considered. This addresses several handicapping issues: deep running symmetrical sails on heavy boats now need to be bigger relative to the space available than asymmetrical sails on lighter boats that sail higher angles in order to collect the same Power Function credits.

First, bowsprits are considered shorter than poles (a reduction factor of 0.9 is applied to TPS) while a correction of height available is taken into account for poles as $0.16 \cdot LSM1$, considering that poles are set higher than the bowsprit.

The power formulation⁹ is:

$$\begin{aligned}
 Power &= 1.00 + |f_{sp}|^{1.5}, \quad \text{but not to exceed } 1.28 \\
 f_{sp} &= \min((1 - 1.488 \cdot SPLc / (SPI_AREA / (ISPc \cdot AWAct))) - 0.17, 0) \\
 SPLc &= SPL \quad \text{or} \quad 0.9 \cdot TPS \\
 ISPc &= ISP \quad (\text{for sprit}) \quad \text{or} \quad ISP - 0.16 \cdot LSM1 \quad (\text{for poles}) \\
 AWAct &= 0.5196 \cdot AWA^{0.1274} \quad \text{if } AWA > 28^\circ, \quad 0.794 \quad \text{if } AWA < 28^\circ \\
 CE_height &= 0.517 \cdot ISPc + 0.16 \cdot LSM1 \quad \text{for poles or } 0.517 \cdot ISPc \quad \text{for sprits}
 \end{aligned} \tag{5.22}$$

In 2014 power function was fine tuned: the upper last 5% of mast height is for free in ISP for the sake of power function calculation: $ISPc = \min(ISPc, 0.95 \cdot (P + BAS))$.

⁹2013

The f_{sp} formulation includes ISP and TPS, so in effect it has dimensions of an area. The AWA factor is a modification on this area to consider a boat type that needs to sail at 175 degrees and can fill the available space with a larger spinnaker more effectively than a boat that needs to sail at 100 degrees that would not benefit from such a large spinnaker. So if a typical A1 area is set at a typical A1 angle, it should reach a similar power factor to a typical S4 or A4 area set at their typically-wider angles. The “Power” function does not credit poles or bowsprits shorter than the norm, and the maximum power increment is 20% above the base level.

In order to calculate the force from the spinnaker/gennaker the sail area is multiplied by the Power function.

5.2.5 HEADSAILS SET FLYING

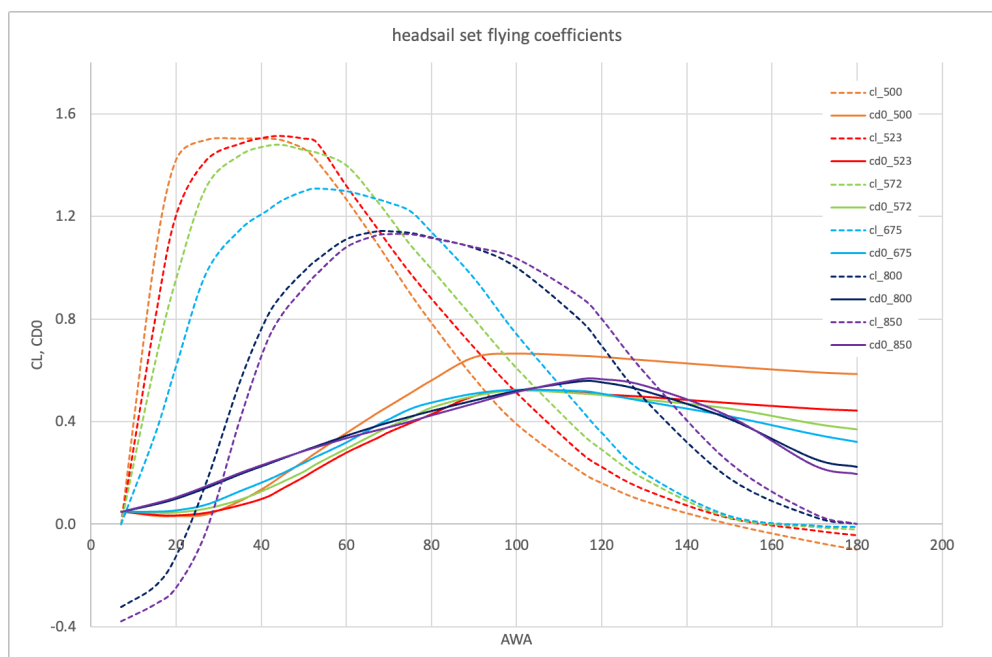

FIGURE 5.12: Aero coefficients of flying headsail

Since 2014 the former code0 has been renamed as *headsail set flying*, and some modifications have been introduced to the rules, affecting the way its area is computed, and its performances. The flying headsail area is now measured similarly to the jib and genoa (which are headsails too, but not set flying). In 2020 the concept of headsail set flying has been further refined and modified, with important changes in the approach. The reason for changing approach was the advent of cableless sails, which made useless the test for identifying a loose-luffed or a tight luff sails. In 2022 the aerodynamic coefficients have been slightly adjusted.

Regarding the aerodynamic coefficients, it has been acknowledged that there is a big variety of flying headsails: they could be conceived for close reaching and upwind sailing similarly to a genoa or jib, or they can be designed to give their maximum performance at wider angles. The driver of the sail performances with wind angle has been identified in the ratio of the half width to the LP width, HHW/HLP . Therefore, a matrix of aerodynamic coefficients CL, CD0 has been developed for six different ratios HHW/HLP , ranging from the jib at 50% up to the spinnaker at 85%. Moreover, there is a smooth transition in the remaining aerodynamic variables, like CEH and effective height, from a treatment that is equal to that of a jib for sails with 50% of ratio, to one that is equal to a spinnaker for sails with ratio equal to 85%. For a specific sail, the set of coefficients is selected by interrogating the above matrix, and finding the correct set by interpolation whenever the ratio HHW/HLP does not coincide with one of the six.

For the above reasons, being each flying headsail different, there is a VPP run for each one of these, contrary to the approach used for jibs and spinnakers, where only the largest of each type is used. Moreover, with every sail run, very little depowering is allowed, with a minimum *reef* equal to 0.91.

Another feature to be noted is that the set of coefficients is defined for ratios HHW/HLP up to 85%. This is already in the spinnaker region. When an spinnaker has a ratio SHW/SFL smaller than 85%, beside the usual run with the spinnaker coefficients, also a run with the headsail set flying coefficients is performed. The transformation from SHW/SFL ratio to HHW/HLP is carried using the position $HHW/HLP = SHW/SFL$. Such approach ensures that

there is no jump in performances between a sail declared as a spinnaker with $SHW/SFL = 0.751$ and the same sail declared as an headsail set flying with $HHW/HLP = 0.749$.

AERO COEFFICIENTS

AWA	cl_500	cd0_500	cl_523	cd0_523	cl_572	cd0_572	cl_675	cd0_675	cl_800	cd0_800	cl_850	cd0_850	kcl	kcd
7	0.000	0.050	0.000	0.050	0.000	0.050	0.000	0.050	-0.324	0.048	-0.380	0.048	1.000	0.830
15	1.050	0.032	0.800	0.037	0.630	0.044	0.350	0.050	-0.243	0.077	-0.314	0.081	1.028	0.830
20	1.425	0.031	1.210	0.035	0.960	0.045	0.620	0.055	-0.123	0.099	-0.247	0.105	1.040	0.830
27	1.500	0.037	1.420	0.045	1.315	0.060	0.980	0.077	0.160	0.141	-0.029	0.147	1.055	0.830
35	1.505	0.090	1.485	0.075	1.440	0.095	1.150	0.130	0.558	0.195	0.410	0.200	1.060	0.830
41	1.505	0.145	1.510	0.105	1.475	0.135	1.220	0.170	0.797	0.231	0.698	0.235	1.060	0.880
45	1.498	0.190	1.515	0.140	1.480	0.165	1.265	0.200	0.898	0.256	0.820	0.258	1.058	0.880
50	1.465	0.245	1.505	0.185	1.460	0.205	1.300	0.240	0.986	0.287	0.920	0.285	1.056	0.880
53	1.418	0.280	1.490	0.215	1.450	0.235	1.310	0.265	1.031	0.305	0.975	0.300	1.055	0.880
60	1.267	0.355	1.320	0.280	1.400	0.295	1.300	0.320	1.112	0.345	1.080	0.335	1.055	0.930
67	1.100	0.430	1.160	0.335	1.265	0.355	1.270	0.385	1.142	0.382	1.125	0.365	1.055	0.970
70	1.025	0.460	1.090	0.360	1.200	0.380	1.255	0.410	1.142	0.397	1.131	0.378	1.055	0.980
75	0.900	0.510	0.980	0.395	1.090	0.415	1.222	0.450	1.136	0.420	1.130	0.400	1.052	0.990
80	0.785	0.560	0.880	0.430	0.995	0.455	1.140	0.475	1.118	0.442	1.115	0.424	1.049	0.994
90	0.570	0.650	0.690	0.500	0.800	0.500	0.960	0.510	1.077	0.483	1.080	0.470	1.040	0.998
100	0.390	0.664	0.513	0.522	0.608	0.522	0.741	0.525	1.001	0.520	1.035	0.515	1.033	1.000
115	0.205	0.656	0.281	0.512	0.357	0.510	0.451	0.520	0.795	0.558	0.885	0.565	1.027	1.000
120	0.160	0.652	0.224	0.507	0.291	0.504	0.357	0.510	0.695	0.554	0.800	0.565	1.025	1.000
130	0.090	0.639	0.136	0.498	0.176	0.486	0.200	0.480	0.488	0.520	0.592	0.540	1.015	1.000
150	0.000	0.614	0.024	0.474	0.024	0.451	0.032	0.422	0.178	0.411	0.240	0.420	1.000	1.000
170	-0.070	0.592	-0.024	0.451	-0.012	0.392	-0.006	0.352	0.027	0.255	0.039	0.228	1.000	1.000
180	-0.100	0.585	-0.043	0.444	-0.022	0.370	-0.011	0.322	0.000	0.224	0.000	0.195	1.000	1.000

TABLE 5.11: Aero coefficients of flying headsails. The names carry a number corresponding to the HHW/HLP ratio. The two rightmost columns are the multipliers of CL and CD for battened sail

AREA CALCULATION AND LEGACY CONVERSION

The area formula for flying headsail is the same as for jibs/genoa (now all called headsails):

$$Area = 0.1125 \cdot HLU(1.444444HLP + 2HQW + 2HHW + 1.5HTW + HUW + 0.5HHB) \quad (5.23)$$

The old code0s area was based on spinnaker formula:

$$Area_{old} = \frac{0.5(SLU + SLE)(SFL + 4SHW)}{6} \quad (5.24)$$

During the transition 2013-2014 for legacy code0s a conversion formula that preserves $HHW/HLP = SHW/SFL$ has been adopted. This formulation derives some virtual girths, based on the old spinnaker-like measures SHW , SFL , SLU , and SLE . Moreover, a factor is applied to the old area calculation, in order to reproduce the same performances with the new approach.

TRANSITION 2013-2014 formulas

$$Area = 0.94 * A_{old}$$

$$MFR = SHW/SFL$$

$$HLU = SLU$$

$$HHW = MFR * HLP$$

$$HHB = 0.05 * HLP$$

$$HUW = 0.25 * HHW + 0.75 * HHB$$

$$HTW = 0.5 * (HHB + HHW)$$

$$HQW = 0.5 * (HLP + HHW)$$

with above relations it results, after simplifications:

$$HLP = Area / [0.1125 * HLU * (2.544444 + 4 * MFR)]$$

DEFAULT AREA

The headsail set flying has a default area defined as the area of the foretriangle defined by TPS and ISP :

$$area_{default} = \frac{ISP_n}{6} \cdot \left(4 \cdot TPS_n \cdot \frac{SHW}{SFL} + TPS_n \right) \quad (5.25)$$

A flying headsail is not taken into account by the VPP if it is declared to be flown internal to the forestay.

5.3 WINDAGE FORCES

The windage drag is incorporated into the force balance by adding to the aerodynamic drag a windage drag determined from equation 5.26. Each of the (n) windage elements is ascribed its own dynamic head (q_n) based on an apparent wind velocity appropriate to its centre of effort height (ZCE), reference area (A_{ref}) and drag coefficient (Cd).

$$D_{WINDAGE} = \sum_1^n q_n \cdot A_{ref} \cdot Cd_n \quad (5.26)$$

The windage drag for each element is calculated at apparent wind angles of 0 and 90 degrees, while at intermediate angles the drag coefficient is calculated as

$$Cd = [Cd_{front} \cdot A_{front} \cdot \cos \beta \operatorname{sgn}(90 - \beta) + Cd_{side} \cdot A_{side} \cdot \sin \beta] / A_{ref} \quad (5.27)$$

β being the local apparent wind angle at the center of effort height of the selected windage element. The calculation of Centre of Effort Height (ZCE), Drag Coefficient ($Cd0$) and reference area (A_{REF}) at apparent wind angles of 0 and 90 degrees is shown in the table 5.12 below, the values for 180 degrees are the same as those for the headwind case. In table 5.12 rfm is the amount of mainsail reefing (see sec.5.1.3), while ehm is the static effective height, calculated

Apparent. Wind Angle 0°			
WINDAGE ELEMENT	ZCE	Cd	A _{REF}
HULL	0.66(FBAV+Bsinφ)	0.816	FBAV*B
MAST-Sail	HBI+EHM*rfm/2	0.4a	Front Area
MAST-Bare	HBI+EHM*(1-rfm)/2	0.8a	Front Area
RIGGING	HBI+I/2	1.0b	I*f(Default Rigging wt.)
CREW	HBI+0.5+B/2 sin φ	1.08	0.25
Apparent. Wind Angle 90°			
WINDAGE ELEMENT	ZCE	Cd	A _{REF}
HULL	0.66(FBAV+Bsin φ)	0.816	f(HSA ₀ , φ)
MAST-Sail	HBI+EHM*rfm/2	0.6a	Side Area
MAST-Bare	HBI+EHM*(1-rfm)/2	0.8a	Side Area
RIGGING	HBI+I/2	1.0b	I*f(Default Rigging wt.)
CREW	HBI+0.5+B/2sin φ	1.08	0.5*Mvblcrew
a modified by EDM factor for non standard mast section aspect ratio.			
b plus spreader factor = 0.2			

TABLE 5.12: Windage force model

as $ehm = \max(P \cdot tf + BAS, I, ISP)$, where $tf = 0.16Z_m/P + 0.94$, Z_m being the vertical distance of the centroid of mainsail area measured from the boom.

The rated hull side area (HSA_0), at zero heel is:

$$HSA_0 = \int_0^{LOA} Freeboard w(x) dx = fb_0 \cdot LOA \quad (5.28)$$

where fb_0 is the average freeboard with boat upright, $fb_0 = \frac{\int_0^{LOA} freeboard w(x) dx}{\int_0^{LOA} w(x) dx}$; the weight function $w(x)$ linearly increases from a value of 0.375 at the stern station to a value of 0.625 at the bow station, therefore weighing more the topsides in the bow.

In 2017 the calculation of the heeled hull side area has been refined: the old formulation took into account an increase due to heel based on a simple $\sin \phi$ formula:

$$HSA_{\phi} = HSA_0 + 0.75 \cdot IMSB/2 \cdot \sin \phi \cdot LOA \quad (5.29)$$

The new formulation is

$$HSA_{\phi} = fb_{\phi} \cdot LOA \quad (5.30)$$

where fb_{ϕ} is the calculated average freeboard when the boat is heeled at angle ϕ . This formulation leads to more precise results in particular for light and wide yachts, where the old formulation underestimated the heeled hull windage area.

Regarding the mast windage, there is a limit in the mast longitudinal diameter:

$$MDL_{max} = 0.036 \cdot \left(IG \cdot \frac{RM@25}{25} \right)^{0.25} \quad (5.31)$$

when the limit is exceeded, the excess is added to the mainsail girths and headboard. Also, if the mast is recorded as a rotating one, the windage of the mast is assumed to be zero and the mast side area is added to the mainsail area.

Concerning the windage of the crew, since 2019 it is computed basing the drag on the *default* crew weight, and no more on the *declared* crew weight.

5.3.1 RIGGING

The drag of the rigging wire is calculated based on the default rigging weight. The square root converts wire cross-sectional area to wire diameter, and the factor of 2 means four stays.

$$Diameter_of_Rigging_wire = 2 \sqrt{(4 \cdot WT_Default / I / Steel_density / \pi)} \quad (5.32)$$

$$Area_Rigging_Wire_windage = I \cdot Diameter_of_Rigging_wire \quad (5.33)$$

$$Cd0_Rigging_wire = Cd_Rigging_Wire \cdot (1 + spreader_Factor_windage) \quad (5.34)$$

For non-round rigging the diameter of rigging wire is decreased by 50%.

SPREADERS

If the rig has bona-fide spreaders their drag is added in as a multiplier as shown in equation 5.34, where *spreader_Factor_windage* is set to 0.2.

5.4 TOTAL AERODYNAMIC LIFT AND DRAG

The next phase is to combine the individual sail's characteristics to produce a set of lift and drag coefficients that describe the aerodynamic behavior of the entire rig.

This is accomplished by a weighed superposition of the individual sail force coefficients at each apparent wind angle. This process is described in more detail in section 5.4.1.

The weight given to each sail's coefficients during this process is proportional to the product of its area and the "blanketing" factor, which modifies the individual sails coefficients depending on the apparent wind angle. After summing the weighted coefficients the total is normalized with respect to the reference sail area (A_{ref}).

When calculating the collective vertical centre of force the weight given to each sail's contribution is proportional to the product of the area, the blanketing factor, and the total force coefficient.

The induced drag coefficient is calculated from knowledge of the effective rig height. *heff*

$$CD_I = \frac{CL^2 \cdot A_{ref}}{\pi \cdot heff^2} \quad (5.35)$$

The effective rig height is calculated from the sail plan geometry at each iteration of the VPP through the aerodynamic force calculation loop.

The effective rig height is a function of:

- the mainsail roach
- the relative positions of the mainsail head and the jib head expressed as "fractionality" and
- the overlap of the headsail
- the depowering

5.4.1 LIFT AND DRAG OF COMPLETE SAIL SET

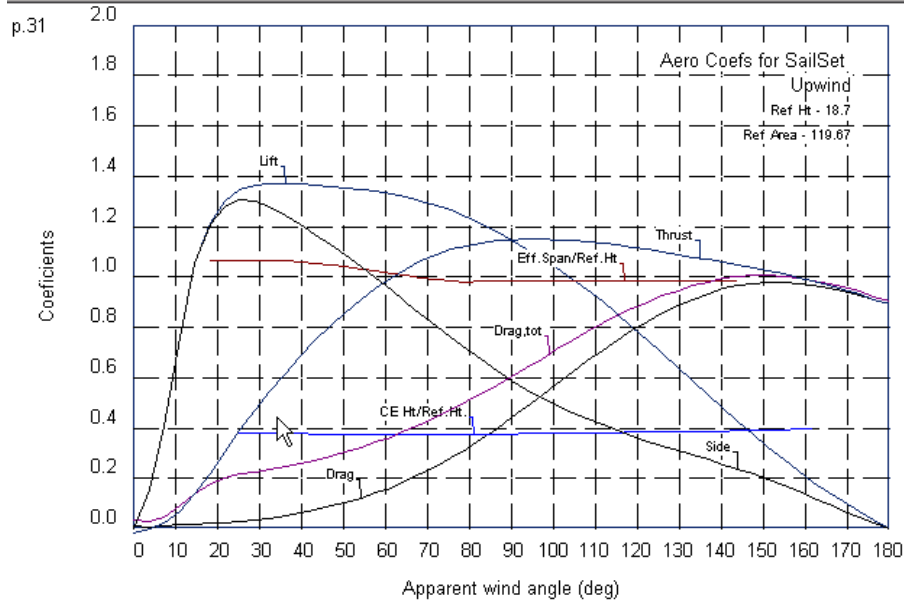

FIGURE 5.13: Typical Form of “Collective” Upwind Sail Force Coefficients

The aggregate maximum lift and linear parasite drag coefficients are the sum of each sail component’s contribution normalized by reference area, and modified by a blanketing function bk_i :

$$CL_{max} = \sum CL_{max_i} \cdot bk_i \cdot \frac{A_i}{A_{ref}} \quad (5.36)$$

$$CD_{0max} = \sum Cd_{0max_i} \cdot bk_i \cdot \frac{A_i}{A_{ref}} \quad (5.37)$$

$$(5.38)$$

A typical form of the collective sail force coefficients is shown in Figure 5.13. The “Drag” Curve is the parasitic drag contribution, and the Total Drag curve includes the induced drag contribution.

5.4.2 CENTER OF EFFORT HEIGHT

Center of effort height Z_{ce} is evaluated by weighting each sail’s individual center of effort height by its area and partial force coefficient (comprised of lift and linear component of parasitic drag):

$$Z_{ce} = \frac{\sum Z_{ce_i} \cdot \sqrt{CL_{max_i}^2 + CD_{0max_i}^2} \cdot bk_i \cdot A_i}{A_{ref} \cdot \sqrt{CL_{max}^2 + CD_{0max}^2}} \quad (5.39)$$

TWIST FUNCTION

In order to reflect the fact that as sails are de-powered the centre of effort height moves lower a “twist function” was introduced, relating the center of effort height to the amount of *flat* used. The extent of the centre of effort lowering was determined from wind tunnel test results, which showed that this effect was proportional to the fractionality $I/(P + BAS)$ ratio.

$$Z_{CE} = Z_{CE}|_{flat=1} \cdot \left\{ 1 - [0.500 \cdot (1 - flat) + 0.902 \cdot (1 - flat) \cdot (1 - frac)] \cdot \left[1 - \frac{overlap - 0.9}{0.6} \right] \right\} \quad (5.40)$$

Fractional rigged boats more effective lowering of the centre of effort position as the *flat* parameter reduces is shown in Figure 5.14. Moreover, in 2024 the formulation has been modified and a term dependent from the overlap has been added, differentiating boats having jibs with large overlap from those having no overlap, as can be appreciated in 5.14.

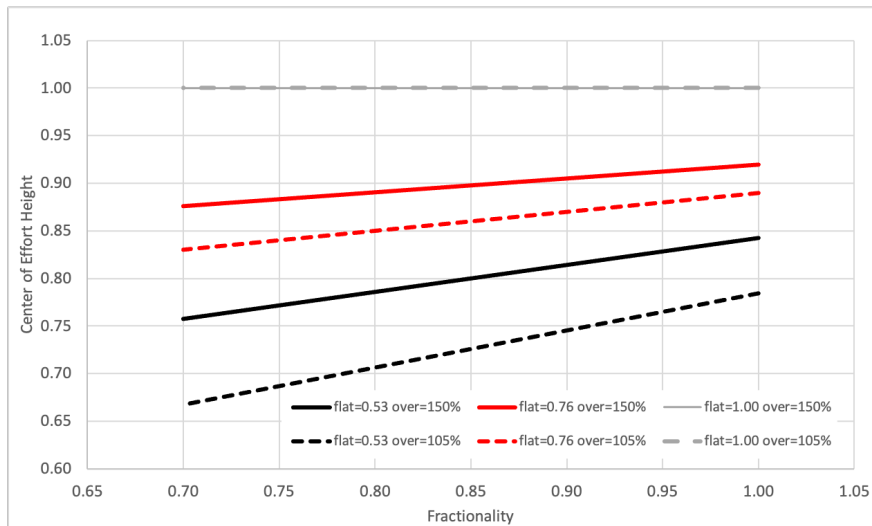
FIGURE 5.14: *Twist Function*

5.4.3 INDUCED DRAG

In order to calculate the induced drag component an efficiency coefficient is derived. The efficiency coefficient is such that when multiplied by the collective lift coefficient squared it yields the collective induced drag of the sails. The efficiency coefficient is comprised of 2 parts;

- The 2 dimensional part describing the increase of viscous drag that occurs as the sail produces more lift,
- and the “induced drag” which depends on the effective rig height.

QUADRATIC PARASITE DRAG

The viscous drag of the sails varies according to the square of the lift coefficient. This quadratic parasite drag coefficient KPP is the sums of the individual sails contributions:

$$KPP = \frac{\sum KPP_i \cdot CL_{max_i}^2 \cdot bk_i \cdot A_i}{A_{ref} \cdot CL_{max}^2} \quad (5.41)$$

EFFECTIVE RIG HEIGHT

Three parameters - *fractionality*, *overlap* and *roach*- are determined in order to calculate the Effective rig height which determines the induced drag of the sails.

$$\begin{aligned} \text{Fractionality} &= I_{current} / (P_{current} + BAS) \\ \text{Overlap} &= LPG_{current} / J \\ \text{Roach} &= \text{see eq. (5.3)} \end{aligned}$$

The influence of sail plan geometry is first calculated to derive a corrected effective span coefficient.

$$eff_span_corr = 1.1 + 0.08 \cdot (Roach - 0.2) + 0.5 \cdot (0.68 + 0.31 \cdot fractionality + 0.075 \cdot overlap - 1.1) \quad (5.42)$$

The effective span coefficient is approximately 1.10 with a masthead rig (*fractionality* = 1.0), 150% overlap genoa and a roach of 0.2.

The effective span coefficient is then further modified to reflect the fact that as the sails are eased at wider apparent wind angles the effective span is reduced as the sealing of the jib and the hull is lost and the sail interactions become less favourable. With jib we have:

$$cheff_{upwind} = eff_span_corr \cdot kheff \quad (5.43)$$

The term $kheff$ varies from 1.45¹⁰ at 20 degrees to 0.80 as the apparent wind angle widens from 20 to 80 degrees (Figure 5.15):

¹⁰Revised in 2023

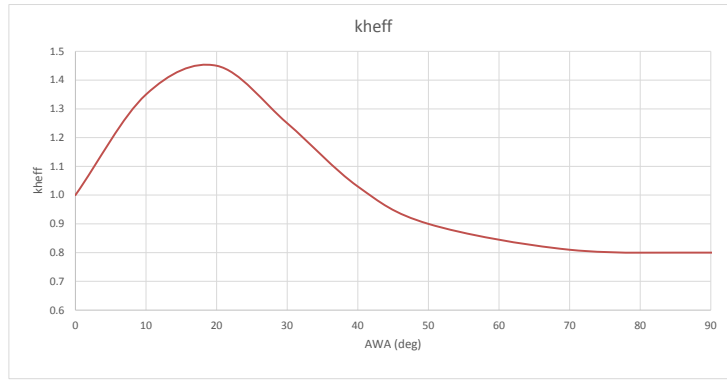

FIGURE 5.15: Variation of Effective Span Factor with Apparent wind angle

With spinnaker the effective height calculation is simpler, being independent of the apparent wind angle and on the foresail geometry:

$$cheff_{downwind} = \frac{1}{b_{max}} heff_height_max_spi \cdot reef \quad (5.44)$$

where

$$\begin{aligned} heff_height_max_spi &= \max(P \cdot tf + BAS + HBI, PY \cdot tfy + HBIY) \\ tf &= \frac{0.16(CEH_{main} - 0.024)}{P} + 0.94 \\ tfy &= \frac{0.16(CEH_{miz} - 0.024)}{PY} + 0.94 \end{aligned}$$

Finally the effective height $heff$ is calculated from the product of $cheff$ and the the highest point of the sail plan b above the water surface. This is either the mainsail head ($P + BAS$) or jib head (IG). If the jib head is higher than the mainsail head then the average is taken.

$$heff = cheff \cdot (b + HBI) \quad (5.45)$$

For headsail set flying, the approach is that of averaging the model adopted for jib and spinnaker, weighing differently the two, depending on the value HHW/HLP : on the spinnaker side ($HHW/HLP = 0.75$) the model is the one used for spinnakers, on the jib side ($HHW/HLP = 0.50$) the model used is that of jib, while for intermediate value there is a weighted linear combination of the two.

The efficiency coefficient CE is comprised of the induced drag coefficient and the parasitic drag coefficient that is proportional to lift squared.

$$CE = KPP + \frac{A_{ref}}{\pi \cdot heff^2} \quad (5.46)$$

where the reference area is the total sail area. Finally at each apparent wind angle the total lift and drag coefficient for the sails can be calculated from the lift, and drag coefficients and the “efficiency coefficient” (CE).

$$CD_{sailset} = CD0_{max} \cdot [FLAT \cdot f_{cdmult} \cdot f_{cdj} + (1 - f_{cdj})] + CE \cdot CL_{max}^2 \cdot FLAT^2 \cdot f_{cdmult} \quad (5.47)$$

$$CL_{sailset} = FLAT \cdot CL_{max} \quad (5.48)$$

where

$$f_{cdj} = \frac{bk_{jib} \cdot CD0_{max,jib} \cdot A_{jib}}{CD0_{max} \cdot A_{tot}}$$

is the fraction of parasitic drag due to the jib. The FLAT parameter characterizes a reduction in sail camber such that the lift is proportionally reduced from the maximum lift available. Thus flat = 0.9 means 90% of the maximum lift is being used.

What this means in practice is shown in Figure 5.16, in “full power” conditions (FLAT=1) the available aerodynamic force is determined by the maximum Cl and associated Cd . The total Cd at max Cl is affected by Cdp and by the effective rig height that determines the induced drag component. When the sails are flattened to reduce the total force, and therefore the heeling moment, it does so along the Cd vs. Cl^2 line shown in Figure 5.16. In 2014, the so called depowering curve, Cd vs. Cl^2 of the sailplan was modified in order to follow the non linearities found

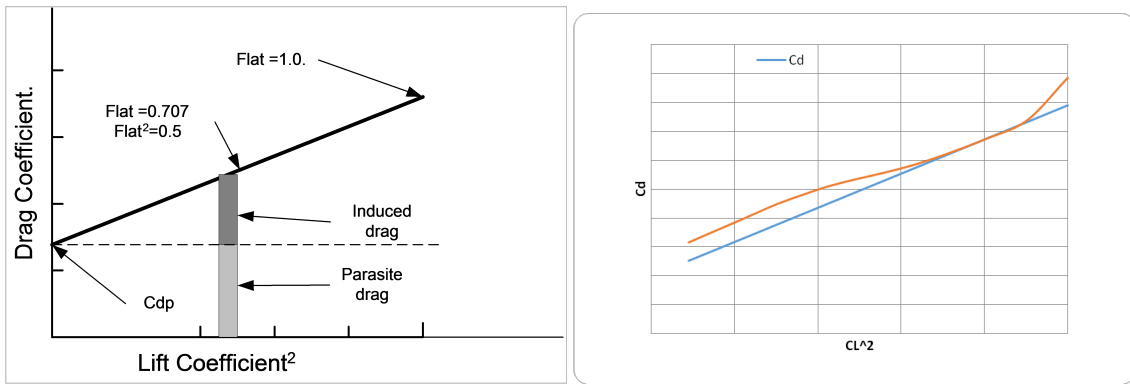

FIGURE 5.16: Variation of Drag Coefficient with Flat parameter (left), modification of the linear depowering scheme, f_{cdmult} , (right)

in the wind tunnel (and in the reality!): both at full power and when the sail are well depowered (that is when the flat parameter is below 0.8), an increase of the drag is found compared to the linear behavior (see Figure 5.16, the blue line represents the linear model, red line the modified). For doing this, a multiplier f_{cdmult} is applied to the drag coefficient of the sailplan, which depends on the position along the depowering curve, in other words on the flat parameter:

Flat	0.10	0.20	0.30	0.40	0.50	0.55	0.60	0.65	0.70	0.75	0.80	0.85	0.90	0.95	1.00
f_{cdmult}	1.06	1.06	1.06	1.06	1.06	1.06	1.055	1.048	1.035	1.020	1.008	1.002	1.000	1.004	1.06

Therefore the non linear relation $Cd - CL^2$ (red line in figure 5.16, right) is obtained.

5.5 RESOLUTION OF FORCES

Throughout the evolution of the VPP, in the past there has been a trend that the VPP appeared to overstate the value of high righting moment. This has been particularly noticeable in light airs on windward/leeward courses, i.e. Mediterranean conditions.

Two strategies have been adopted in the aerodynamic force model to overcome this, the PHI_UP , parameter and the twist function (see par.5.4.2). The PHI_UP function was artificially reducing the heel effect on the sailplan, thus avoiding a degradation of performance with heel the was exploited for obtaining more favourable handicap. In 2023, after several years where the aero model has been modified in its coefficients, in its depowering scheme and in the calculation of induced drag, the effect of the PHI_UP parameter has been eliminated.

5.5.1 THRUST AND HEELING FORCE

In order to determine the total thrust and heeling moment the aerodynamic forces are resolved into two orthogonal components; along the yachts track (CR) and perpendicular to the mast plane (CH). The windage forces are then added to these components.

The collective lift and drag forces from aerodynamic model are resolved as follows:

$$CR = CL \sin \beta - CD \cos \beta \quad (5.49)$$

$$CH = CL \cos \beta + CD \sin \beta \quad (5.50)$$

The coefficients are translated into forces:

$$FRA_B4_Windage = CR \cdot \frac{1}{2} \rho V_a^2 \cdot A_{ref} \quad (5.51)$$

$$FHA_B4_Windage = CH \cdot \frac{1}{2} \rho V_a^2 \cdot A_{ref} \quad (5.52)$$

Where:

$$\begin{aligned} \rho &= \text{air density} \\ V_a &= \text{apparent wind speed} \\ A &= \text{reference sail area} \end{aligned}$$

The total aerodynamic force (FRA) and the heeling force (FHA) are then calculated by adding the windage components:

$$FRA = FRA_{B4_Windage} + FRA_{hull} + FRA_{mast} + FRA_{Rigging_Wire} + FRA_{Crew} \quad (5.53)$$

$$FHA = FHA_{B4_Windage} + FHA_{hull} + FHA_{mast} + FHA_{Rigging_Wire} + FHA_{Crew} \quad (5.54)$$

5.5.2 AERODYNAMIC HEELING MOMENT

The aerodynamic heeling moment is the sum of the sail heeling moment ($HMA_{B4_Windage}$) and the heeling moment from the windage elements.

$$HMA = HMA_{B4_Windage} + HMA_{hull} + HMA_{mast} + HMA_{Rigging_Wire} + HMA_{Crew} \quad (5.55)$$

The sail heeling moment is the product of the heeling force (CH) and the moment arm above the waterline.

$$HMA_{B4_Windage} = \frac{1}{2} \rho V_a^2 \cdot A_{REF} \cdot CH \cdot (HBI + ZCE \cdot REEF) \quad (5.56)$$

5.6 BLANKETING FUNCTIONS

5.6.1 MAINSAIL

$$bk(\beta) = \begin{cases} 1 & \text{if } \beta \leq 90 \\ 1 - 0.5 \cdot f_m \left(1 - 1.5 \cdot \frac{\beta - 135}{45} - 0.5 \cdot \left[\frac{\beta - 135}{45} \right]^3 \right) & \text{if } \beta > 90 \end{cases}$$

where

$$f_m = \frac{1.16 \cdot A_{miz_staysail}}{A_{main}}$$

Clearly $f_m = 0$ for sloops or for a boat without a mizzen staysail. The factor 1.16 is a backward compatibility multiplier, that originated when the internal vpp mainsail area was assumed equal to the actual rated area, and no more that same area divided by 1.16 (which was a number probably related to the average roach used many years ago).

5.6.2 JIB

$$bk(\beta) = \begin{cases} 1 & \text{if } \beta \leq 135 \\ 1 - f_j \frac{\beta - 135}{45} & \text{if } \beta > 135 \end{cases}$$

where

$$f_j = \frac{A_{jib} - \min(A_{jib}, A_{fore})}{A_{jib}}$$

5.6.3 MIZZEN, JIB DOWNWIND, SPINNAKER

$$bk(\beta) = 1$$

5.6.4 MIZZEN STAYSAIL

$$bk(\beta) = \begin{cases} 1 - f_{ys} \left[1 - 1.5 \cdot \frac{\beta - 135}{45} - 0.5 \cdot \left(\frac{\beta - 135}{45} \right)^3 \right] & \text{if } \beta \geq 90 \\ 1 & \text{if } 90 > \beta \geq 60 \\ 1 - \left[\left(\frac{60 - \beta}{15} \right)^2 \right] & \text{if } 60 > \beta > 45 \\ 1 & \text{if } \beta \leq 45 \end{cases}$$

where

$$f_{ys} = \frac{A_{mizzen}}{1.16 \cdot A_{miz_staysail}}$$

6 HYDRODYNAMIC FORCES

The VPP hydrodynamic force model divides the drag into two sources; viscous or skin friction drag arising from the flow of the water over the immersed surface, and residuary or wave making drag arising from the creation of surface waves.

The VPP can make performance predictions not only for conventional fin keel yachts, but also water ballasted and canting keel yachts that have asymmetric rudder and keel configurations. Whilst the estimate of performance for these yachts is based on plausible physics, there has been a deliberate policy not to reach a situation where these types of yachts are favored.

During 2012 the hydrodynamic resistance formulation underwent a significant revision. This resulted in deriving a new R_r formulation based only on BTR and LVR using a methodology to assess for each Froude number (Fn) the R_r variation related to a base boat having $LVR = BTR = 6$. The Length model was also modified to more correctly represent a dynamic length.

Also the viscous resistance formulation was modified to more sensibly capture the appropriate reference length of contemporary canoe body shapes.

6.1 VISCOUS RESISTANCE

The total frictional resistance is the sum of the appendage and canoe body contribution.

$$D_{FRICITION} = R_{VC} + R_{VA} \quad (6.1)$$

6.1.1 CANOE BODY

The viscous resistance is calculated as¹:

$$R_{VC} = \frac{1}{2} \cdot \rho V^2 \cdot Area \cdot (C_f \cdot ff) \quad (6.2)$$

where

$$\begin{aligned} ff &= 1.05 \\ C_f &= \frac{0.066}{(\log 10Re - 2.03)^2} \\ Re &= \frac{0.85V \cdot LSM1}{\nu} \end{aligned}$$

so for 2013 the friction line (Hughes in way of ITTC57), the form factor (1.05, it was 1.00), and the reference length (0.85LSM1 in way of 0.7LSM1) were modified. ν is the water kinematic viscosity, and V is the boat velocity.

6.1.2 APPENDAGES

The currently implemented scheme divides each appendage into five segments as shown in Figure 6.1, and determines the viscous coefficient of resistance of each strip based on the local (strip specific) Reynolds Number and thickness/chord (t/c) ratio.

The viscous resistance of each strip is then calculated from the product of the dynamic head, the local wetted surface area and an appropriate skin friction resistance coefficient (C_f) multiplied by a form factor ($1 + k_f$).

Since 2022 the old tabular interpolation among different coefficients set for only three values of tcr (0, 0.10, 0.20) is replaced by a continuous function based on thickness to chord ratio tcr . There is no change to the fundamental approach. There is a cap on the maximum tcr at 18% to discourage very short and fat profiles.

¹Major change 2013

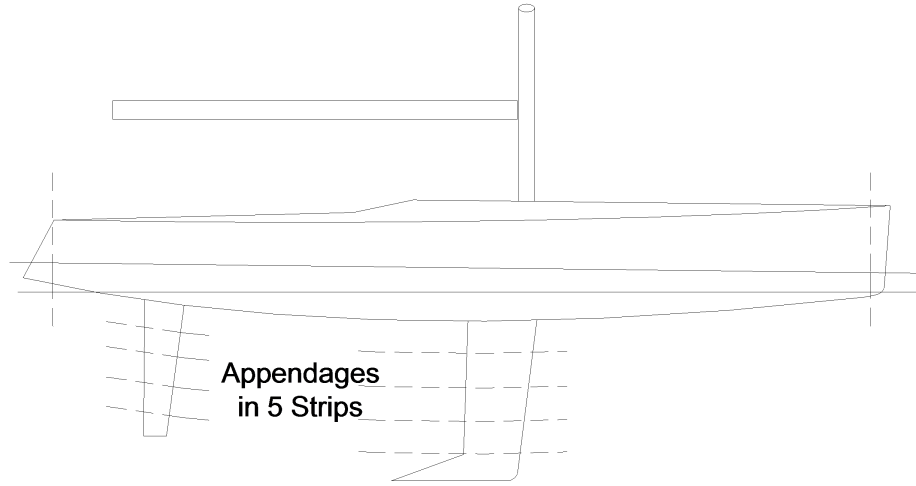

FIGURE 6.1: Stripwise segmentation of appendages

The frictional coefficients formula is

$$c_{f0} = 0.0000853(\log Rn)^4 - 0.0025252(\log Rn)^3 + (0.0278513 \log Rn)^2 - 0.1363492 \log Rn + 0.2539752 \quad (6.3)$$

while the form factor is

$$k_f = 1.75tcr + 30tcr^4 \quad (6.4)$$

The viscous drag is calculated as

$$R_v = c_f \cdot (1 + k_f) \cdot A \cdot 0.5\rho v^2 \quad (6.5)$$

Regarding the bottom strip, if a bulb is found and flagged, the viscous drag is calculated using a different form factor, with a cap of 0.25 on the thickness-chord ratio:

$$k_{fb} = -13.1753tcr^3 + 9.3842tcr^2 - 0.7581tcr + 0.1442 \quad (6.6)$$

The bulb existence is flagged when the first bottom strip is longer more than 20% more than the one just above. In this case, the first strip variables are calculated in a different way, addressing the more three dimensional shape of the bulb compared to a fin keel. For a bulb, the chord is computed as the maximum longitudinal distance between offsets points belonging to the first strip; the max thickness is then computed as $(1.6 \cdot str_vol / str_area) / 0.66$.

In 2020 the effect of the lift on the drag of the appendage has been introduced. In order to take this into account, the effects of the CL on the CD were evaluated using as a reference a NACA 64014 foil for a Rn of 2 million and a N_{crit} value of 1 using Xfoil. The relationship between CL and CD is modeled as:

$$CD = C_f + 0.0016 \cdot CL + 0.0032 \cdot CL^2 \quad (6.7)$$

which is based on the results on a NACA 64014 foil, tested with a $Rn = 2 \cdot 10^6$, and $N_{crit} = 1$. The increase of the CD is capped to that corresponding to a CL of 0.5. This means that no yacht will see an increase in the calculated keel and rudder viscous resistance greater than about 20%. The keel and rudder CL values are to be calculated based on the estimated side force load sharing which changes with the heel angle.

The total viscous drag of the appendages is determined as follows:

$$R_{VA} = \frac{1}{2} \rho V^2 \left(\sum_{N=1}^5 [A_{stripN} CD(rudder)_{stripN} + A_{stripN} CD(keel)_{stripN}] \right) + \quad (6.8)$$

$$\frac{1}{2} \rho V^2 (A_{centerboard} CD_{centerboard} + A_{canard} CD_{canard}) \quad (6.9)$$

The approach to very long keels drag has been modified in 2023: when the top strip of the keel is longer than 65% of LSM1, in this case the keel frictional coefficient is assumed to be the same as the one of the canoe body.

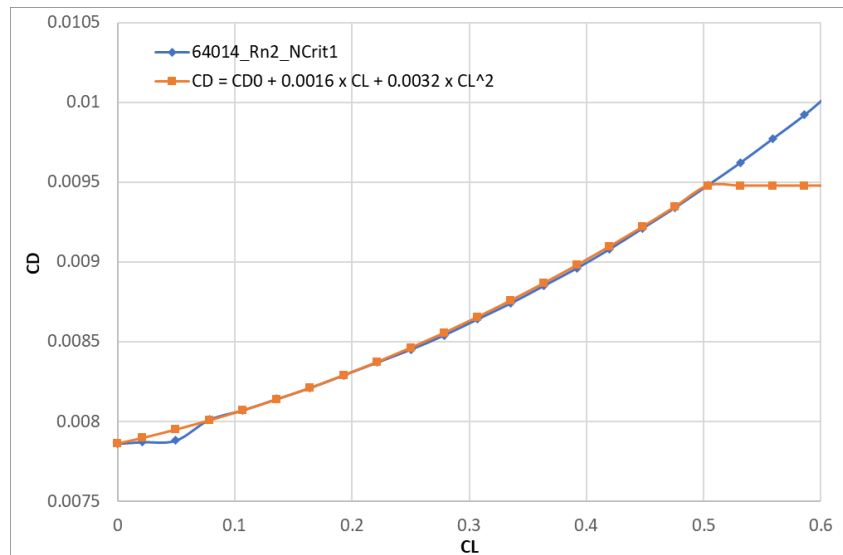

FIGURE 6.2: Increase of appendage drag with lift.

DOUBLE RUDDERS (2010)

The Offset file has now been configured to accept double rudder configurations as detailed in Appendix A. The viscous drag is calculated according to Table ??, with no velocity deficit for the keel wake. The immersed wetted area is calculated at each heel angle assuming an undisturbed static waterplane.

CENTERBOARDS

Because centerboards are often not as well refined as keel fins a different drag formulation² is adopted:

$$\text{Centerboard_drag} = 0.006 \cdot 12\rho V^2 \cdot A_{cb} \quad (6.10)$$

$$\text{Wetted_Area_Centerboard}(A_{cb}) = 2 \cdot ECM \cdot \frac{CBTC + 2 \cdot CBMC + CBRC}{4} \quad (6.11)$$

where

- ρ = Water density
- ECM = Centerboard extension
- $CBTC$ = Centerboard tip chord
- $CBMC$ = Centerboard mid chord
- $CBRC$ = Centerboard root chord

If there is no data for centerboard chord then the following formula is applied:

$$\text{Wetted_Area_Centerboard}(A_{cb}) = 2 \cdot 0.6 \cdot ECM^2 \quad (6.12)$$

DAGGER BOARDS, BILGE BOARDS

Bilge boards and dagger boards are treated as per Table ?? based on their area and mean chord length.

²1987

TRIM TABS

The use of a trim tab to reduce the viscous drag of the keel fin by shifting the viscous “drag bucket” to higher lift coefficient is reflected in a formula that reduces the viscous drag coefficient for a keel with a trim tab³.

$$CL = 0.75 \frac{Side_force}{q \cdot A} \quad (6.13)$$

$$CD = 0.0097 \cdot CL^2 + 0.00029CL + 0.0034 \quad (6.14)$$

$$CD_diff = 0.33(CD - 0.0034) \quad (6.15)$$

where A is the keel area and q is the dynamic head $0.5\rho V^2$. CD_diff is subtracted from the keel strip friction drag coefficient.

6.2 PROPELLER

The drag of the propeller is calculated as follows:

$$D_{prop} = \frac{1}{2} \rho V_s^2 \cdot 0.81 \cdot PIPA \quad (6.16)$$

PIPA is calculated according to the following formulae which depend on the type of installation.

6.2.1 SHAFT INSTALLATION

For all propellers with shaft installation, IPA is calculated as follows:

$$IPA = (0.04 + \sin^3 PSA) \cdot [PSD(ESL - ST2 - PHL) + ST4(ST2 + PHL)] + 0.03ST1 \cdot \left(ST5 - \frac{ST4}{2} \right) \quad (6.17)$$

FOLDING AND FEATHERING 2 BLADE

$$PIPA = IPA + 0.65(0.9PHD)^2 \quad (6.18)$$

FOLDING AND FEATHERING 3 BLADE

$$PIPA = IPA + 0.70(0.9PHD)^2 \quad (6.19)$$

FOLDING AND FEATHERING 4 BLADE

$$PIPA = IPA + 0.754(0.9PHD)^2 \quad (6.20)$$

For a folding propeller PHD shall not be taken greater than $3.5 \cdot PSD$ in the above formulas, while for a feathering propeller PHD shall not be taken greater than $4.0 \cdot PSD$.

SOLID 2 BLADE

$$PIPA = IPA + 0.10PRD^2 \quad (6.21)$$

SOLID 3 BLADES

$$PIPA = IPA + 0.12PRD^2 \quad (6.22)$$

³The form of the code reflects that the drag reduction has been reduced over time because the original formulation was regarded as too punitive in terms of handicap

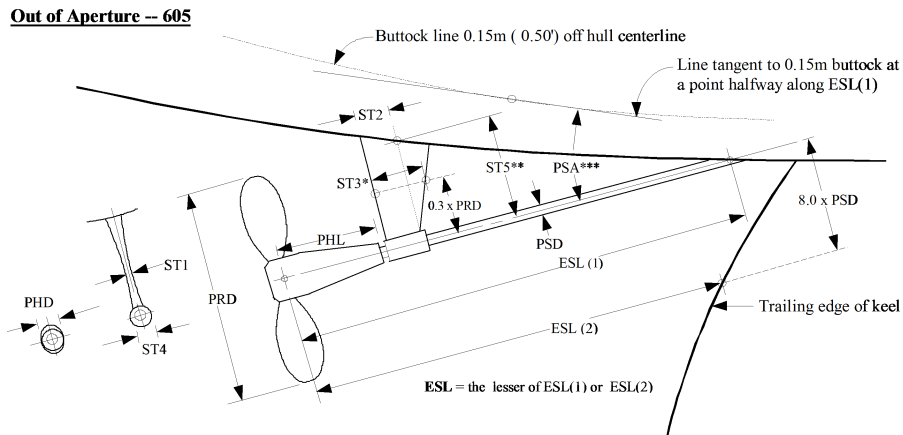

*ST3 is the maximum strut width measured parallel to the propeller shaft found not more than 0.3 x PRD above the shaft centerline.

**ST5 is measured perpendicular to the shaft centerline from the hull to the shaft centerline at the forward end of ST2.

***PSA (Propeller Shaft Angle) may be measured in two steps:

1. Angle between shaft centerline and level datum line
2. Angle between buttock tangent line and level datum line

Add angles to arrive at PSA.

In Aperture -- 606

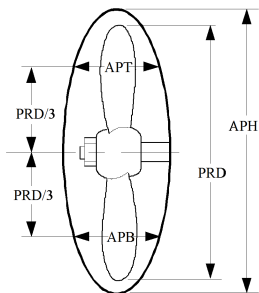

APT and APB are the maximum aperture widths measured parallel to the propeller shaft, found not less than PRD/3 above and below the shaft centerline.

Strut Drive -- 607

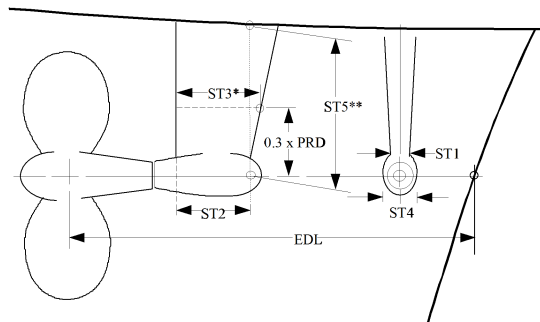

FIGURE 6.3: Propeller Installation Dimensions

SOLID 4 AND MORE BLADES

$$PIPA = IPA + 0.144PRD^2 \tag{6.23}$$

If ESL is less than PRD, PIPA shall be multiplied by 0.5.

6.2.2 STRUT DRIVE

PIPA shall be determined as follows:

FOLDING AND FEATHERING 2 BLADE

$$PIPA = 0.06ST1(ST5 - 0.5ST4) + 0.4(0.8ST4)^2 \quad (6.24)$$

FOLDING AND FEATHERING 3 BLADE

$$PIPA = 0.06ST1(ST5 - 0.5ST4) + 0.42(0.8ST4)^2 \quad (6.25)$$

FOLDING AND FEATHERING 4 BLADE

$$PIPA = 0.06ST1(ST5 - 0.5ST4) + 0.44(0.8ST4)^2 \quad (6.26)$$

SOLID 2 BLADE

$$PIPA = 0.06ST1(ST5 - 0.5ST4) + 0.10PRD^2 \quad (6.27)$$

SOLID 3 BLADE

$$PIPA = 0.06ST1(ST5 - 0.5ST4) + 0.12PRD^2 \quad (6.28)$$

SOLID 4+ BLADES

$$PIPA = 0.06ST1(ST5 - 0.5ST4) + 0.144PRD^2 \quad (6.29)$$

Notes:

1. The shape of the strut may be modified, but the full functionality of the standard model must be retained and $ST1 - ST4$ values may not be reduced below the unmodified standard dimensions. For handicapping purposes $ST1 - ST4$ shall not be taken bigger than the unmodified standard dimensions.
2. $ST4$ shall be measured at the aft end of the hub instead of at the point of maximum projected area, better representing the flow separation drag.
3. An upper $ST4$ limit will be used for the $PIPA$. This limit depends on the L of the yacht. The maximum is defined by a curve of values just above those typical of most common production units, faired over an ample length range. The upper limit for $ST4$ is thus defined as the lesser of:

$$(4 \cdot 10^{-5} \cdot L^3 - 0.0011L^2 + 0.0125L + 0.05) \quad \text{or} \quad 0.2 \quad (\text{but never less than } 0.1) \quad (6.30)$$

4. If a skeg is present in front of the strut, its frictional drag is computed using the same frictional coefficient used for the canoe body viscous drag calculation

6.2.3 IN APERTURE

For propellers of any type installed in an aperture $PIPA$ shall be taken as the least of the values determined by the formulae:

$$PIPA = 0.07 \cdot PRD^2 \quad (6.31)$$

$$PIPA = 0.07 \cdot \left(\frac{APT}{0.4}\right)^2 \quad (6.32)$$

$$PIPA = 0.07 \cdot \left(\frac{APH}{1.125}\right)^2 \quad (6.33)$$

$$PIPA = 0.07 \cdot \left(\frac{APB}{0.4}\right)^2 \quad (6.34)$$

6.2.4 TRACTOR PROPELLERS

For tractor propellers of any type installed out of aperture $PIPA$ shall be zero.

6.2.5 TWIN SCREWS

ORC has an input to signify twin propeller installations. If this is indicated, $PIPA$ is doubled for any type of installation or propeller.

6.3 RESIDUARY RESISTANCE

The residuary resistance is divided into resistance of canoe body and resistance of appendages:

$$D_{RESIDUARY} = Rr_{canoe} + Rr_{appendages} \quad (6.35)$$

Residuary Resistance ('RR') of the canoe body (often known as wave-making resistance) can account for circa 20% to 70% of the total drag of a sailing yacht (speed, size and shape dependant). The calculation is made by taking the average of two parts (50:50):

1. The *old* three input method (in place since 2013) uses a set of interpolation surfaces (F_n , LVR & BTR)
2. The *new* fourteen input method employs a set of Neural Networks enabling the specific determination of resistance coefficients in across a wider design space.

6.3.1 CANOE BODY - RR SURFACES (F_n , BTR , LVR)

The calculation⁴ of the wave-making or residuary resistance is based on the calculation of a residuary resistance coefficient at preset values of Froude Number (F_n). The F_n is a non-dimensional speed based on the yachts Dynamic Length L

$$F_n = \frac{V}{\sqrt{g \cdot L}} \quad (6.36)$$

How the dynamic length is determined is explained below, see *Composite Length Calculation*. The hull is the main element of the residuary resistance, with a small contribution from the appendages.

Recognizing that previous attempts to accurately calculate the effect of several hull parameters such as Prismatic Coefficient, Longitudinal Center of Buoyancy (LCB) and water plane area coefficient have led to undesirable type-formed hull shapes and that this trend could not be addressed within the existing model, it was decided to simplify the input parameters accounting for 2 main parameters only: dynamic Length-Volume ratio ($LVR = L/Vol^{1/3}$), and Beam to Canoe-body-draft ratio (BTR) to avoid as much as possible any type-forming. The effects of hull volume distribution are still captured by the use of the traditional integrated lengths.

⁴Major revision 2013

RESISTANCE SURFACES

The R_r drag curve for the canoe body is formed by the extraction of drag values at 24 Froude numbers (F_n) from surfaces of BTR and dynamic LVR and ranging from F_n 0.125 up to F_n 0.7.

The Froude number used also incorporates dynamic length. For speeds outside this range the resistance is extrapolated. The BTR and LVR ranges of the surface are 2.5 to 9 and 3 to 9 respectively and outside this range the value defaults to that of the closest point of the surface.

The $LVR - BTR$ surfaces are very similar to the example plots below and the points from which they are derived can be downloaded in .CSV file format from www.orc.org/rules.

The CSV file is a tabulation of the coordinates of the surfaces interrogated by the VPP as it calculates the Residuary Resistance per unit of displacement.

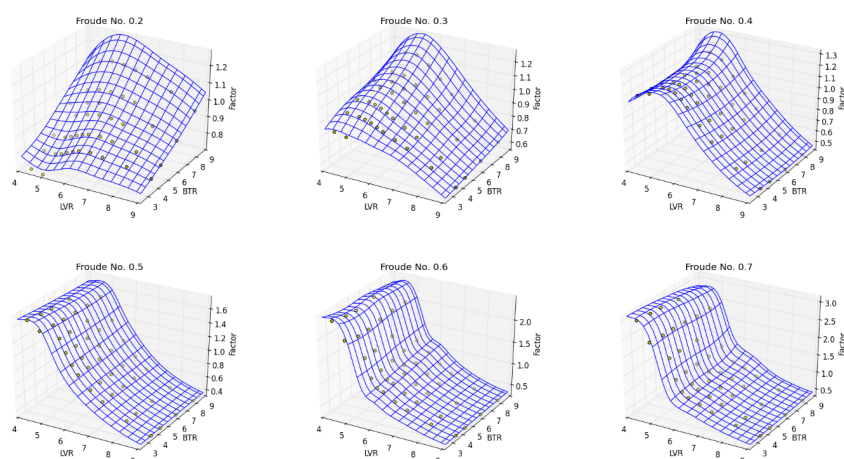

FIGURE 6.4: Typical R_r multiplier at fixed Froude Number

In 2014 fine tuning of RR surfaces was made in areas not very well defined (low LVR , high F_n).

COMPOSITE LENGTH CALCULATION

Up until 2013 2 LSM^5 length values were compounded into a single “L” value used as the reference waterline length to calculate Froude Number. In the 2013 VPP, $LSM1$ was retained, and two new sunk length values were created, $LSM4$ and $LSM6$ which are used only in the determination of residuary resistance. To help with the coding nomenclature the LSM terms used in the calculation of residuary resistance were given the pre-fix RR, i.e. $RRLSM1^6$, $RRLSM4$ and $RRLSM6$.

RRLSM Flotation Planes

RRLSM	Exponent in equation 4.11	Height above Sailing Waterplane	
		Fwd	Aft
RRLSM1	0.3	0	0
RRLSM4	0.4	$RRLSM1 * 0.736 * LVR^{-2.15}$	$RRLSM1 * 1.105 * LVR^{-2.15}$
RRLSM6	0.45	$RRLSM1 * 0.093 * LVR^{-1.2}$	$RRLSM1 * 0.140 * LVR^{-1.2}$

Recognising that the wave height, the dynamic heave and therefore the physical length itself are highly sensitive to both Froude number and Length volume ratio (LVR), a new scheme was developed to improve the treatment of “effective length.” Two new sunk length values were created, namely $RRLSM4$ and $RRLSM6$, aimed at $F_n > 0.35$ and $F_n < 0.35$ respectively. The height of $RRLSM4$ is aimed to match wave heights at F_n 0.4, while the height of $RRLSM6$ is designed to match waves heights at F_n 0.3, and both depend on suitable functions of the yachts length and LVR . $RRLSM6$ has a lower length exponent than $RRLSM4$, because at $F_n < 0.35$ having a lot of volume in the ends rather than in the middle is not as beneficial as it is at $F_n > 0.35$. The static sailing waterplane length $RRLSM1$ has also had its exponent reduced to reflect that it is now only primarily used at slow speeds. The new L is dependent on Froude number, and based on length mixtures which are linearly interpolated in four phases:

⁵LSM: Length Second Moment-see equation 4.11

⁶ $RRLSM1 = LSM1$

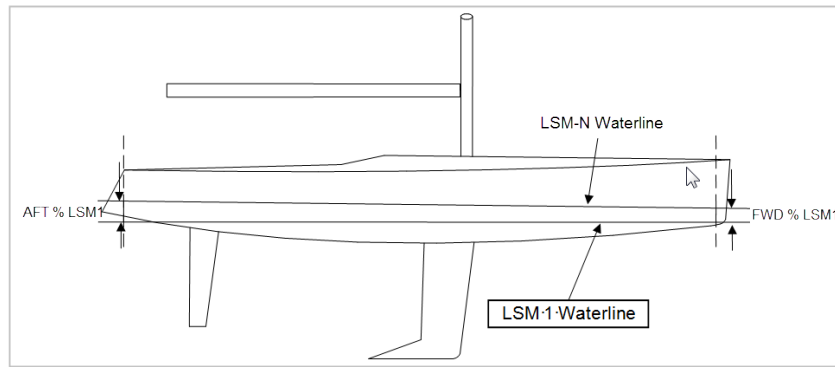

FIGURE 6.5: Floatation planes

- **Phase 1:** $0.125 < Fn < 0.3$ L is a mixture of $RRLSM1$ and $RRLSM6$, starting at 100% $RRLSM1$ and finishing at Fn 0.3 as 100% $RRLSM6$
- **Phase 2:** $0.3 < Fn < 0.4$ L is a mixture of $RRLSM6$ and $RRLSM4$, starting as 100% $RRLSM6$ and finishing as 100% $RRLSM4$
- **Phase 3:** $0.4 < Fn < 0.5$ L is a mixture of $RRLSM4$ and $RRLSM1$, starting at 100% $RRLSM4$ and ending as 70% $RRLSM4$
- **Phase 4:** $0.5 < Fn$ L is a mixture of $RRLSM4$ and $RRLSM1$, continuing as 70% $RRLSM4$

For values of $Fn > 0.4$ the $RRLSM6$ loses relevance, but the wave length grows longer than the hull as the Fn continues to increase, resulting in a reduction of the wave height locally at the transom, so $RRLSM1$ is mixed in to reduce the effective length appropriately, representing a 30% share of L by Fn 0.5 and then continuing at that ratio for higher Froude numbers.

Froude No	0.125	0.2	0.25	0.3	0.35	0.4	0.45	0.5	0.6	0.7
RRLSM 1	1	0.6	0.3	0	0	0	0.15	0.3	0.3	0.3
RRLSM 4	0	0	0	0	0.5	1	0.85	0.7	0.7	0.7
RRLSM 6	0	0.4	0.7	1	0.5	0	0	0	0	0
Sum	1	1	1	1	1	1	1	1	1	1

TABLE 6.1: L calculation scheme

6.3.2 CANOE BODY - RR NEURAL NETWORK MODEL

Accurately calculating RR for a wide range of hull shapes with a fast and accessible model is a notoriously challenging question. Although the *old* RR calculation method detailed above has provided a good base for several years, specific analysis of a mini test fleet of boats has found the model to be underperforming in accuracy in a range of areas. Statistically, across the ORC fleet, this new model provides a higher level of RR prediction accuracy. Almost all boats should receive fairer treatment with some seeing bigger changes than others. The dataset on which the model was constructed (circa 950 CFD points), is an order of magnitude larger than that used to construct the old model and the range of parameters used to generate the hulls (14) is much wider than the previous three, giving much better representation of the ORC fleet. The parameters for these datapoints were carefully and evenly spread across the design space. Similarly to the 'old' method, the new method attempts to avoid using too specific inputs that may result in type forming. To this end, a number of new parameters have been introduced. The LPP calculation mechanism has fundamentally not changed to achieve this, just its output calculations. As before, these inputs are identified at the predicted heel point during a single point optimisation. The list of non-dimensional inputs used is defined below: Inputs 6 to 9 are LSM length ratios to determine the hull's volume distribution at the LSM1 and LSM4 floatations. To calculate these, the depth attenuation and length exponents of eqs. (4.12, 4.11) are varied systematically:

- $LSM1RATIOXYA = LSM1_YA / LSM1_XA$

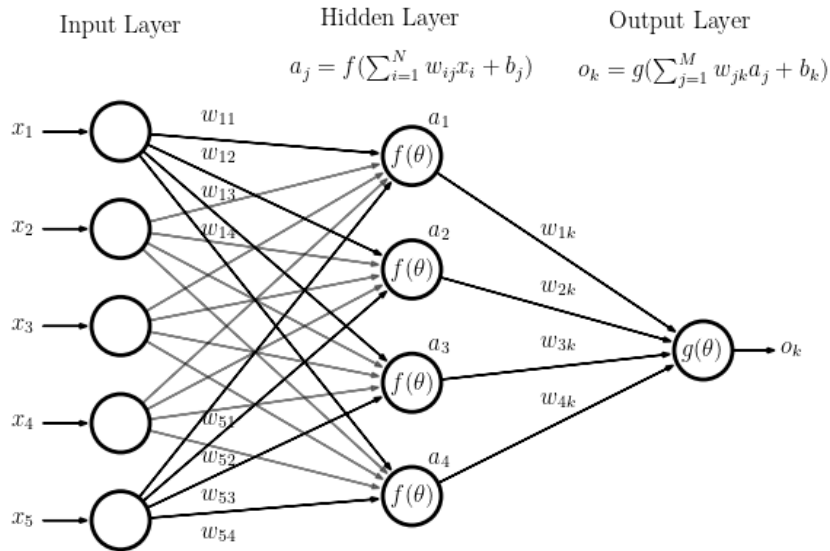

FIGURE 6.6: Typical Neural Network scheme

parameter	description	range
1) Fn	Froude Number, using LSM1 (as per old method)	variable
2) LVR	Length Volume Ratio, using LSM1 (as per old method)	[4.1, 9.0]
3) LVR4	Length Volume Ratio, using LSM4 (as per old method)	[4.5, 9.0]
4) LVR6	Length Volume Ratio, using LSM6 (as per old method)	[4.3, 9.0]
5) BTR	Beam to Draft Ratio, (as per old method)	[3.1, 9.5]
6) LSM1RATIOXYA	Described below	[0.0020, 0.0130]
7) LSM4RATIOXYA	Described below	[0.0028, 0.0192]
8) LSM1RATIOXYB	Described below	[0.0020, 0.0106]
9) LSM4RATIOXYB	Described below	[0.0024, 0.0156]
10) X_MAX_SECT_AREA	longitudinal position of max section area (LWL normalised)	[0.45, 0.75]
11) LCB	Longitudinal centre of buoyancy (LWL normalised)	[0.49, 0.60]
12) LCF	Longitudinal centre of flotation (LWL normalised)	[0.51, 0.61]
13) CWPA	Coefficient of Water Plane Area	variable
14) CM	Coefficient of Maximum section area	[0.58, 0.82]

TABLE 6.2: Hull parameters used by the neural network RR

- $LSM4RATIOXYA = LSM4_YA / LSM4_XA$
- $LSM1RATIOXYB = LSM1_YB / LSM1_XB$
- $LSM1RATIOXYB = LSM4_YB / LSM4_XB$

where X and Y represent 10 and 0 in the power term a (attenuation exponent) of equation (4.12), while A and B represent 2.0 and 2.5 in the length exponent l in equation (4.11).

The model is performing well when the parameters lie within a range of values belonging to the test fleet used to train the network. They are detailed in the table above 6.2. In the uncommon case of some parameter lying outside the range, its value is forced to stay at the closest value within the range. For the *CWPA* parameter a variable range is specified, depending on the *Fn*: while the minimum value is constant at 0.61, the max value is 0.725 for $Fn < 0.34$, then linearly increases from 0.725 to 0.77 at $Fn = 0.36$, then it's kept constant at 0.77 for higher *Fn*.

Also the non dimensional velocity variable (Froude number *Fn*) has a variable upper boundary depending on the LVR value (the lower one is 0.18, and for smaller values the resistance is obtained interpolating between 0 and 0.18). In other words the CFD results were available up to a certain max velocity, which is related to the length-volume ratio (LVR) ratio of the tested hull. Light hulls were tested at higher speeds compared to heavy hulls. When such limit is

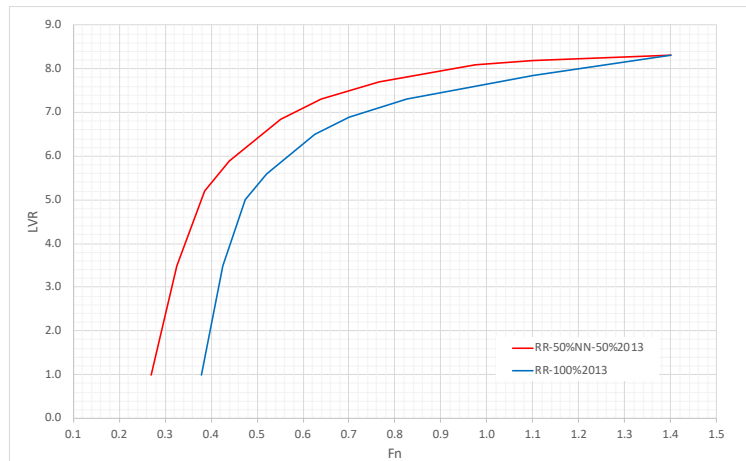

FIGURE 6.7: *LVR-Fn boundaries of RR blending zone*

reached (red line in fig.6.7), the RR 50%-50% mix starts to be linearly modified in favour of the old RR-2013, up to when the second limit (blue line in the same plot) is reached, where the RR is fully computed with the old 2013 model.

Finally, once all the non-dimensional inputs have been determined, they are then input into the neural network calculator. The current model takes the average of three such networks. The network calculator itself is relatively simple (compared to the current generation of neural network based AI systems used for much more complex tasks). It is just a set of standard mathematical calculations using matrices of *weights* and *biases* across layers of *neurons* where at each neuron a simple sum and non-linear function is applied (typically tanh). Figure 6.6 shows an example network design, the actual configurations used are reported in appendix B.

6.3.3 APPENDAGES

Appendage Baseline Residuary Resistance Curves

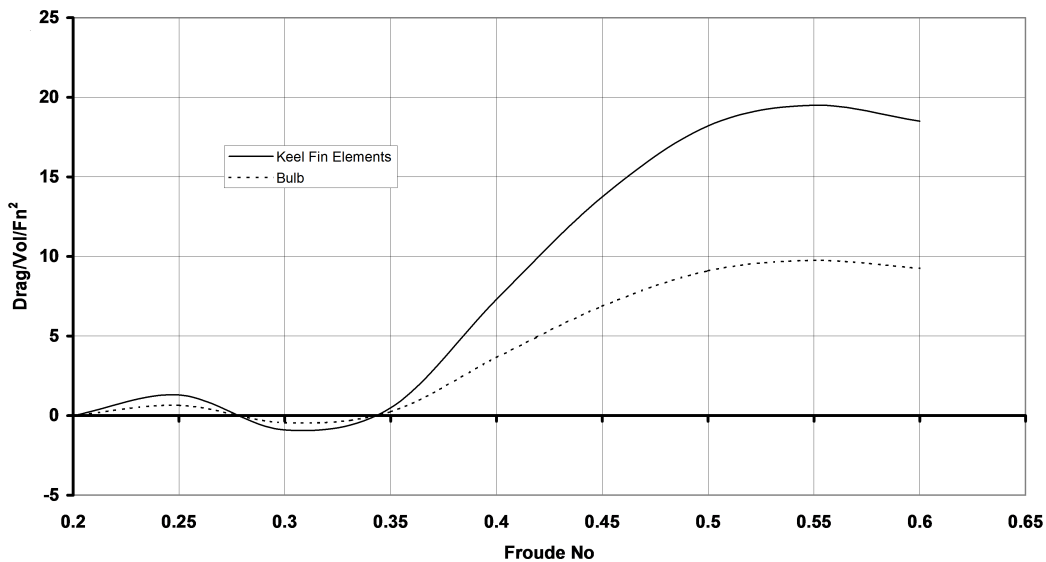

FIGURE 6.8: *Appendage residuary resistance per unit volume at standard depth.*

The original Delft Series models had all been tested with a standard keel and rudder and consequently the original MHS approach was to include the appendages as part of the total displacement for the purposes of calculating residuary resistance. On yachts with hull forms where the appendage/canoe body interface was less than well defined this worked

satisfactorily. Over time however a more sophisticated treatment was sought, and now all of the DSYHS models have been tested as bare canoe bodies. An algorithm for appendage residuary resistance that is sensitive to both keel volume and depth was derived⁷. The residuary resistance of an element of keel or bulb is based on 2 baseline curves shown in Figure 6.8. These show the resistance per unit volume normalized against Fn^2 for an element of keel fin or bulb at the standard depth, $0.1L$ and $0.2L$ respectively. As described in section 6.1.2, the VPP divides the keel into 5 fore and aft strips, stacked on top of each other. The volume and average depth of each strip is calculated. The major factors that influence the wave-making drag of an appendage “strip” are:

1. Appendage strip volume
2. Appendage strip depth below the free surface
3. Boat speed
4. Whether or not that piece of volume is a bulb or part of the vertical foil

Bulbs are more three-dimensional in nature, apparently cause less disturbance to the water flow, and have less drag per unit volume. The drag of bulbs per unit volume is approximately half that of keel strips. The attenuation of drag with depth is approximately linear for both keel strips and bulbs.

Currently, the VPP looks for bulbs only in the deepest strip of a keel. The test criterion is the ratio of the chord length of that deepest strip to the chord length of the strip above it. If that chord ratio is ≥ 1.5 , then the deepest strip is considered to be a bulb. If the ratio ≤ 1.0 , the strip is a keel strip. If the ratio is between 1.0 and 1.5, the drag is found by linear interpolation over chord ratio of the two drags found by treating the strip as a bulb and as a keel.

Where the upper keel strip is determined to be greater than $1.5 \times$ the average of strips 2,3, & 4 then the residuary resistance of the strip is calculated using the “Bulb” residuary resistance line⁸. For traditional style hulls where the keel chord exceeds 50% of $LSM1$ then the keel volume is added to the canoe body volume for the purposes of calculating the residuary resistance.

In 2011 the RR of keels having long chords has been further reduced: a reduction factor is applied to the drag of each keel strip, proportional the ratio of the chord of the strip to $LSM1$. Full drag is given for keels having chords smaller than $0.05 \cdot LSM1$. Then a linear reduction from $c = 0.05 \cdot LSM1$ to $c = 0.15 \cdot LSM1$ is enforced. For chords larger than $0.15 \cdot LSM1$ it is assumed that the RR of that strip is negligible.

6.4 DRAG DUE TO HEEL

A new formulation of the heeled drag is included in the new hydro model based on calculation of heeled viscous and residuary resistance components using the same parameters (Wetted Area, BTR and LVR) but calculated with the boat heeled.

6.5 INDUCED DRAG

This formulation⁹ also takes into account the asymmetry of the heeled hull form, and then considers appendages size (and special configurations like canards and trim tabs) so that leeway angle can be calculated and used to compute the induced drag. The methodology implemented is as follows:

- Formulate lift area (Coefficient of lift multiplied by projected area, abbreviated as “ Cl_a ”) versus leeway angle slopes and axis intercepts for the hull and for the combined appendages, based on simplified lifting line theory for the hull plus a modified version of the lift efficiency modified by BTR and LVR method already in place in the VPP for the appendages;
- Determine from the LPP a hull yaw angle at zero leeway due to the asymmetry of the heeled hull shape. This is based on the transverse shift of the center of buoyancy in the forward and aft end of the hull;
- Combine both hull and appendage lift Coefficient (Cl) vs Leeway lines to create a total coefficient of lift area line (tcl_a) which considers areas and initial slopes (for canard or trim tab yachts, the hull share of lift is assumed to be zero).

⁷Jim Teeters US Sailing

⁸2011 To address the use of high volume keel strakes

⁹Major changes 2013

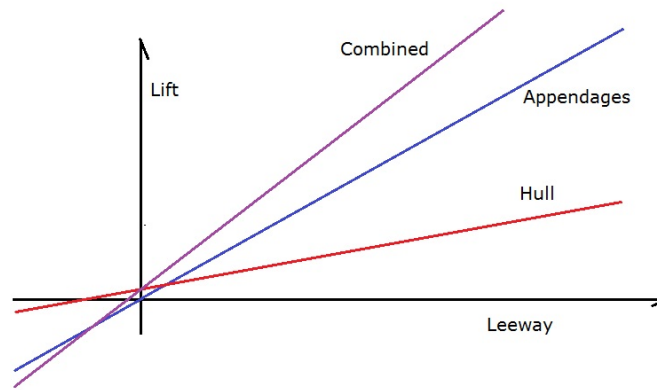
FIGURE 6.9: *Induced Drag*

In the VPP solver operation the procedure is to:

- Divide applied side force by $0.5 \cdot \rho \cdot V s^2$ to obtain the required $tcla$;
- determine leeway at the applied $tcla$;
- determine separate hull and appendage lift shares at the leeway angle obtained;
- From effective spans of hull and appendages, determine the induced drag components DI_j of both canoe body and appendages, using the effective canoe body draft, and the *MHSD* respectively as the (Effective Draft) value in equation (6.37).

$$DI_j = \frac{F_{Hj}^2}{\pi \cdot 0.5 \rho \cdot V^2 \cdot (Effective_Draft_j)^2} \quad (6.37)$$

where

$$\begin{aligned} F_{Hj} &= \text{Heeling Force on the component } j \text{ (appendages or canoe body)} \\ DI_{total} &= DI_{appendages} + DI_{hull}, \text{ with both } DI \text{ components accounted for.} \end{aligned}$$

Along the above procedure, the appendages area is a heel dependent function, where the rudder area is taken as zero when the boat is upright, and increases sinusoidally up to twice its physical area at 30 degrees of heel. This takes into account the increasing contribution to lift of the rudder due to the increase of rudder angle with heel¹⁰.

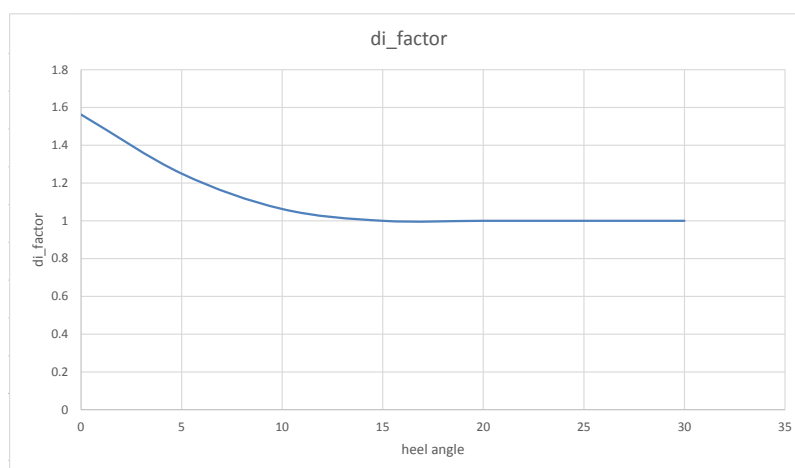
FIGURE 6.10: *Multiplier of induced drag*

¹⁰This functions has been adjusted in 2018, up to 2017 the rudder area started from its physical area upright

Moreover, for taking into account the non optimal sharing of lift between the two appendages (and even the occurrence of negative rudder angles at small heeling angles), in 2018 the induced drag calculated by means of the above scheme is then reparametrised with heel using the multiplier plotted in fig. 6.10. This factor is fully active upwind, then smoothly decreases up to being inactive (that is equal to 1) when the drive to side force ratios become greater than 0.4.

The programmed structure of this method has allowed for the factors to be tuned to match closely the CFD and tank data, and then checked against the existing fleet.

TERM	Description	Conventional	Canting Keel	Canting Keel + CL canard / dagger board	Canting Keel & twin daggerboards
Wave Trough	Wave Trough Keel Root emergence	1.0	1.0	0.5	0.0
Hull Asymmetry	Hull asym. angle used in canoe body lift	Yes	Yes	Yes	Set to zero regardless of calculated hull asym. angle
MHSD	Effective draft Calculation	MHSD	Use keel projected area on hull centre-plane for lift calculation	Use keel projected area on hull centre-plane for lift calculation, or max draft of canard.	Use maximum achievable draft , And use daggerboard area for lift calculation, and projected area for canted keel
FunSteady	FunSteady	1.0	Should always be in credit, cut off is $MHSD = 19\%$ Length	Should always be in credit, cut off is $MHSD = 19\%$ Length	Should always be in credit, cut off is $MHSD = 19\%$ Length

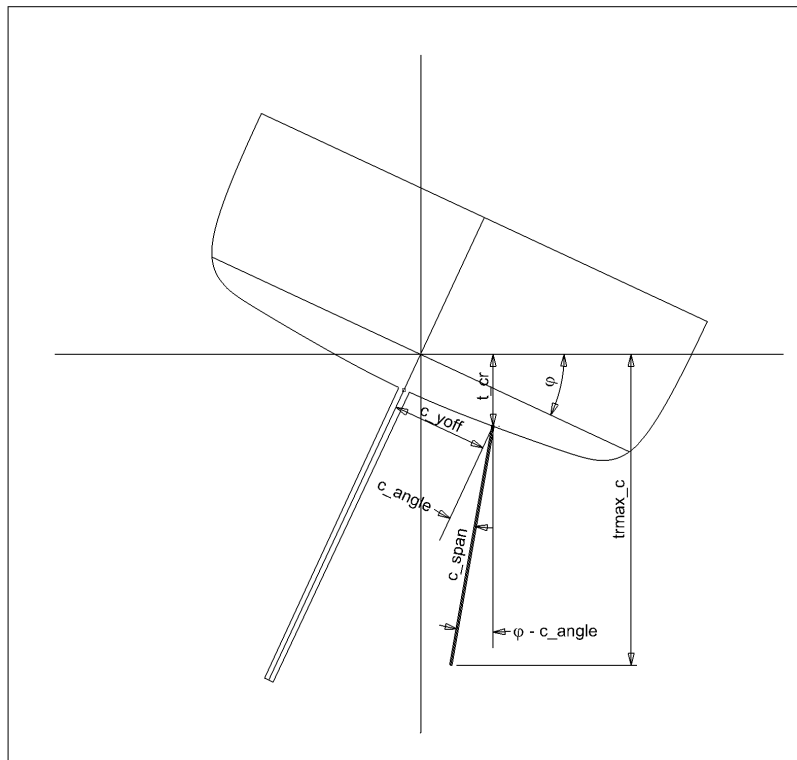

FIGURE 6.11: Scheme of bilgeboards and related variables

When a boat has a canting keel plus daggerboards, the transverse inclination of the daggerboard is properly accounted for the calculation of effective draft at all heel angles. Taking into account the heel angle ϕ , the longitudinal and transverse position of the canard (c_{xoff} and c_{yoff} respectively), the shape of the boat section at the canard

root, the canard span and its angle c_angle to the longitudinal centerplane, angle, the draft of the canard when the boat is heeled is determined as:

$$trmax_c = t_c_root + c_span \cdot \cos(c_angle - \phi) \quad (6.38)$$

This draft is compared to the keel effective draft, and the maximum is taken for the sake of induced drag calculation.

6.5.1 CORRECTION FACTORS

In 2013, beside the new method for assessing the induced drag, also the correction factors of the effective draft were computed with different algorithms, which empirically accounts for the keel root proximity to water surface and for unsteady effects that are not captured by the steady solution of the VPP.

KEEL ROOT FREE SURFACE FACTOR

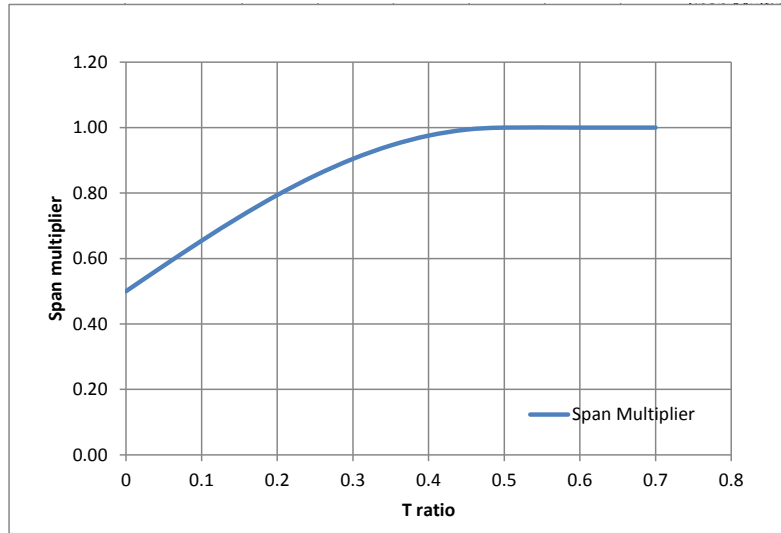

FIGURE 6.12: Keel root free surface factor

A first correction is introduced for the effective span, based on the proximity of the keel root chord to the free surface. It's calculated as

$$beff_{av_{mult}} = 0.5 \cdot (beff_{peak} + beff_{trough}) \quad (6.39)$$

where the $beff$ for peak or trough is:

$$beff = 0.5 + 0.5 \cdot \sin(\pi \cdot tratio) \quad (6.40)$$

The function $beff(tratio)$ is plotted in Figure 6.12.

The parameter $tratio$ is computed for both extrema of the wave (peak and trough), and is constrained within the range $[0, 0.5]$:

$$tratio_{peak} = 2 \cdot dist_{max} / (0.15LSM1) \quad (6.41)$$

$$tratio_{trough} = 2 \cdot dist_{min} / (0.15LSM1) \quad (6.42)$$

where

$$dist_{max} = z_{root} + h_{dyn} + 0.5 \cdot h_w \quad (6.43)$$

$$dist_{min} = z_{root} + h_{dyn} - 0.5 \cdot h_w \quad (6.44)$$

is an estimation of the distance of the keel root chord from the free surface. This distance depends on the position z_{root} of the root chord in static condition, on the correction h_{dyn} of the free surface in dynamic conditions, and on a wave of

estimated height h_w , produced by an “energy” E_w which is a function of the true wind speed TWS :

$$h_{dyn} = -0.087641 \cdot LSM1 \cdot fact_{Fn} \cdot \exp(-0.417 \cdot lvr) \quad (6.45)$$

$$h_w = 0.25 TWS \cdot \left[2 \cdot \frac{E_w}{\rho \cdot g} \right]^{1/2} \quad (6.46)$$

$$E_w = TWS \cdot [1 - 0.8375(1.174^{-0.00248 TWS^{3.5}})] \quad (6.47)$$

For boats with double canard (daggerboard) no reduction is given, thus $beffav_{mult} = 1$, while for boats with single canard the credit is halved: $beffav_{mult} = beffav_{mult} + 0.5 \cdot (1 - beffav_{mult})$.

FUNSTEADY

The *funsteady* term takes empirically into account the difficulty of reaching the maximum performances after maneuvering. It is a multiplier which is made by a term based on the ratio of wind speed and boat displacement.

$$funsteady = 1 - \frac{1}{200} \cdot \left[\frac{TWS - 10}{(Vol + 3)} \right]^2 \quad (6.48)$$

where *funsteady* is lower bounded by 0.9. *Vol* is the volume of the canoe body.

6.6 IMMERSSED TRANSOM

The following section describes a generic wave height calculation procedure for assessing the immersed transom areas as a function of Froude Number and the calculation of the drag due to the immersed transom. The height of the wave at the end of the static WL was found from the wave elevation observations of 13 non appended models of the Delft Systematic Series to be approximately

$$WH_{WLend} = a1 \cdot \frac{VLR_{mult}}{10} \cdot LSM1 \cdot c_{vlr} \quad (6.49)$$

where

$$VLR_{mult} = 2.1 \left[\frac{VOL_c^{1/3}}{LSM1} \right]^{1.5} \quad (6.50)$$

$$a1 = 1.233 \cdot \log(Fn) + 1.985 \quad (6.51)$$

$$c_{vlr} = \min(VLR_{mult}/0.15, 1.0) \quad (6.52)$$

Two different stern flow conditions are considered.

1. In the case of the flow separation from the profile of the overhang the wave height at the transom with a standard overhang length of $0.135 \cdot LSM1c$ is calculated by linear interpolation from the wave height at the end of the static waterline WH_{WLend} and the point of separation which is defined as the non-dimensional length $a2$

$$WH_{stdOverhLength} = WH_{WLend} \cdot \left(1 - \frac{1}{a2} \right) \quad (6.53)$$

where

$$a2 = \min(56(Fn(L) - 0.20)^{1.75} \cdot Overh_{separPt}(Fn=0.3), 1.0) \quad (6.54)$$

$$Overh_{separPt}(Fn=0.3) = 0.30 + \left(\frac{0.115}{VLR_{mult}} \right)^4 \quad (6.55)$$

being the overhang separation point at $Fn=0.3$

2. In the case of transom flow separation, which occurs when $a2$ is becoming 1 or greater, the wave height at the transom with a standard overhang length of $.135 * LSM1c$ is calculated as

$$WH_{stdOverhLength} = WH_{end} \cdot a3 \cdot a4(i+x) \quad x = 0, \dots, 3 \quad (6.56)$$

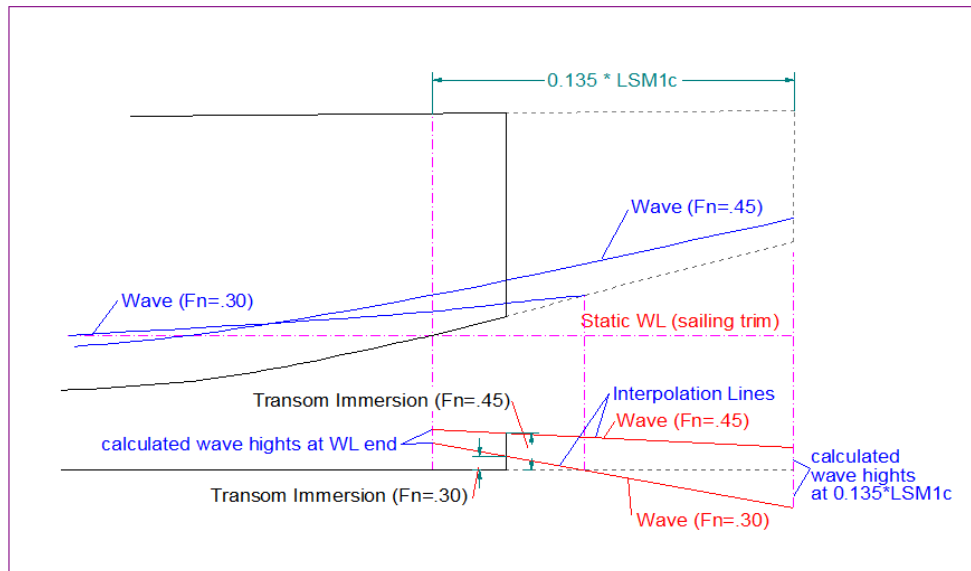

FIGURE 6.13: Principle of estimating transom immersion

with

$$a3 = \frac{(1.1 - Fn)}{0.975} \quad (6.57)$$

and with $a4$ being a degradation factor with increasing Fn 's and (i) denoting the Fn -index at which $a2$ becomes 1.

$$\begin{aligned} a4(i) &= 0.25 \\ a4(i+1) &= 0.5 \\ a4(i+2) &= 0.75 \\ a4(i+3) &= 1 \end{aligned} \quad (6.58)$$

The wave height at the real transom is again calculated by linear interpolation as

$$WH_{stern} = dWH \cdot \left(\frac{0.15LSM1c - Overhang}{0.15LSM1c} \right) + WH_{stdOverhLength} - \min(z_{tran}, 0) \quad (6.59)$$

where z_{tran} is the height of the transom lower edge above the static waterplane, and

$$dWH = WH_{WLend} - WH_{stdOverhLength} \quad (6.60)$$

$$Overhang = LSM5c - LSM1c \quad (6.61)$$

$LSM5c$ being the LSM of the boat sunk to the lowest point of the transom, if above WL . In 2011 the wave height at the transom was reduced by the trim effect of shifting the crew 10% of $LSM1$ forward¹¹.

In 2012 the transom height (above or below the waterline) used for the calculation of the immersed transom drag has been modified taking into account the possibility of moving the crew toward the bow for minimizing it.

This is done by an iterative process: first the immersed transom drag is calculated, and evaluated at $Fn = 0.350$. If there is any transom drag at that velocity, the transom height above the waterline is increased by an amount corresponding to a crew shift forward of $0.01L$. Then the check is performed again. If there is still a non zero drag, the transom height is increased again by the same amount. The process continues up to a maximum shift of the crew toward the bow of $0.15L$. At that stage, any nonzero immersed transom drag is considered the most reliable estimate of this resistance component.

The immersed transom area is the area below a horizontal plane of the height $WH_{aboveWL}$.

$$WH_{aboveWL} = WL_{stern} + H_{Tprof} \quad (6.62)$$

¹¹This was done to discourage the adoption of extreme stern down trim

with H_{Trprof} being the intersection of the transom and the regression line from the profile points of the afterbody of the hull.

The viscous drag component due to an immersed transom is calculated by means of Hoerner's formula for the base drag of a fuselage with a truncated tail end.

$$Cd_{hull} = 0.029 \cdot \frac{(A_{Tr} - AMS1c)^{1.5}}{Cd_{hull}} \quad (6.63)$$

where

A_{Tr}	=	the immersed transom area as calculated by the above outlined procedure
$AMS1c$	=	the midship section area in sailing trim
Cd_{hull}	=	$Rf_{hull} / (\rho / 2 \cdot v^2 \cdot AMS1c)$
Rf_{hull}	=	the frictional resistance of the canoe body

6.7 RAIL-UNDER DRAG

Rail-under drag is not intended to calculate the drag of immersing the lee rail, it is an artifice intended to prevent the VPP finding equilibrium sailing conditions at high heel angles. Rail-under drag is zero up to a heel angle of 30 degrees. Above this value the upright residuary resistance is multiplied by a factor and added to the total drag.

$$D_{RU} = 0.0004 \cdot D_{RESIDUARY} \cdot (\phi - 30)^2 \quad (6.64)$$

6.8 ADDED RESISTANCE IN WAVES, R_{AW}

The addition of an added resistance in waves (RAW) module to the VPP¹² was brought about by the fact that cruising yachts, with outfitted interiors, were disadvantaged relative to their "stripped out" racing rivals. This is not surprising, since reducing the yacht's moment of inertia by concentrating weight close to the centre of gravity will yield a performance gain when sailing in waves. The US Sailing funded project to introduce this feature into the VPP had three aims which tackled the fundamentals of predicting R_{AW} :

1. Define a sea spectrum (wave energy density function) appropriate to the sailing venue
2. Devise a plausible and appropriately sensitive physical model of how parametric changes to the yacht affect RAW when sailing in the sea state defined in 1
3. Devise a method by which a yacht's pitch inertia could be determined directly by a physical test, in the same way that stability is measured by an inclining test.

6.8.1 WAVE CLIMATE

As part of the research prior to introducing the RAW module, US Sailing funded the deployment of a wave height measuring buoy at several popular sailing venues. The buoy was deployed during typical races and the water surface elevations were recorded together with the wind speed. On the basis of these measurements a single definition of wave climate was derived in the form of a wave energy spectrum normalised for a true wind speed of one knot. This approach has the merit that it is relatively easy to apply, because, whilst the significant height becomes a function of wind speed the modal period remains fixed at 5 seconds. When this experimentally-derived linear variation of wave energy with wind speed was implemented it was found that the magnitudes of RAW were too high. Added resistance effects were seen to be dominating handicaps in 6 to 8 knots of wind when the sailors could see that no waves were present on the race course. In order to correct this, a "bubble" (or more correctly a dimple) was put in the curve that defined the wave energy as a function of wind speed.

In 2017 and then in 2020 the bubble has been further decreased, and a length dependency has been introduced. This has been done by defining three baselines for length of 25, 45 and 75 feet. For any length in between the energy is found by linear interpolation of the baselines. For length exceeding the maximum or lengths below the minimum, the energy of the baseline curve is used.

Figure 6.14 shows on the left the original linear sea-state factor together with the 1999 reduction and 2020 baselines, and on the right the numerical values of the three baselines for 2020.

¹²1990

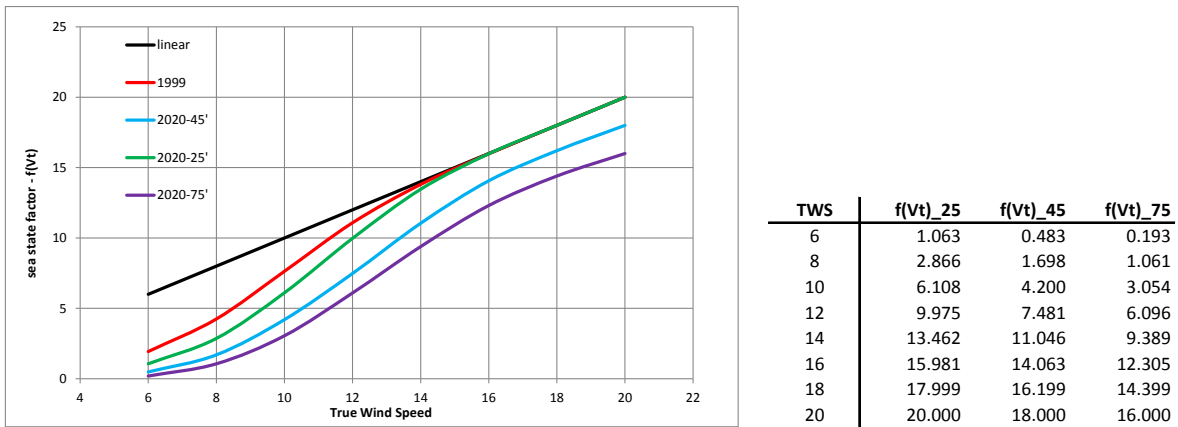

FIGURE 6.14: Wave Energy as a function of True Wind Velocity

6.8.2 DETERMINATION OF ADDED RESISTANCE RESPONSE

Equation 6.65 shows how the added resistance is calculated from the product of the wave energy spectrum and the R_{AW} RAO. The wave spectrum in each wind speed is defined by a constant multiplied by $f(V_t)$, the modulation function discussed in the previous section, that depends on the true wind speed V_t . The task facing the handicappers was to produce RAO values for parametric variations of sailing yacht hull forms.

$$\bar{R}_{AW} = 2 \cdot \int_0^{\infty} \frac{R_{AW}}{\zeta_a^2} \cdot S_{\zeta}(\omega) d\omega \quad (6.65)$$

Equation 6.66 shows the formulation¹³ and the baseline parametric values are shown in Table 6.3.

$$R_{AW} = f_s \cdot 2\rho g L \cdot f(V_t) \cdot 0.55 \cdot f(\beta_T) f(L_{30}) [0.00146 + f(Fn) + f(K_{YY}) + f(L/B) + f(B/T) + f(LCB - LCF)] \quad (6.66)$$

In 2017 the influence of the term depending on LCB and LCF has been removed. In 2020 the GYR term has been reduced by 33% by changing the constant term from 0.01575 to 0.010395. The active terms are defined as

$$L = 0.3194 \cdot (2 \cdot LSM1 + LSM4) \quad (6.67)$$

$$f(Fn) = 0.00191(Fn - 0.325) \quad (6.68)$$

$$f(k_{YY}) = 0.010395 \cdot (GYR - 0.25) \quad (6.69)$$

$$f(L/B) = \frac{5.23^{-L/B} - 5.23^{-3.327}}{8.494} \quad (6.70)$$

$$f(B/T) = 0.000166 \left(\frac{B}{T_C} - 4.443 \right) \quad (6.71)$$

$$f(L_{30}) = 0.5059 \log \left(\frac{L}{30} \right) + 1 \quad (6.72)$$

$$f(\beta_T) = \frac{\cos \beta_T}{\cos 40} \quad (6.73)$$

$$(6.74)$$

In equation 6.66 the f_s factor provides a means to adjust the added resistance values and perhaps can be thought of as a sea energy or strength coefficient. A value of 0.64 is used.

The 0.55 factor represents the wave direction function, necessary because the R_{AW} calculations for the series were done in head seas, while yachts sail at approximately 45 degrees to the prevailing wind and sea direction.

The $f(\beta_T)$ function makes the added resistance a cosine function of heading with 40 degrees true wind (wave) heading as the basis.

The remaining functions in equation 6.66 take the difference between the boat and the base boat and then evaluate the increase or decrease in R_{AW} . The calculation of R_{AW} is done using the physical parameters (L, B, T_C) appropriate to the sailing heel angle.

¹³1999

PARAMETER	SERIES RANGE	BASE VALUE
GYR	0.2-0.32	0.25
L/B	2.77-4.16	3.327
L^3/∇	103-156	125
LCB	0.50-0.56	0.53
LCF	0.54-0.60	0.57
B/TC	–	4.443
Fn	–	0.325

TABLE 6.3: Added Resistance in Waves; parametric limits and base values

DETERMINATION OF PITCH RADIUS OF GYRATION (K_{YY})

The third element of the added resistance calculation is the determination of the pitch inertia of the yachts hull and rigging.

A yachts base radius of gyration is calculated from equation 6.75, and then other declared features of the yachts construction and rig accrue adjustments (*Gyradius_inc*) to this base gyradius.

$$K_{YY} = 0.222 \frac{LSM4 + LSMH}{2} \quad (6.75)$$

where

$$LSMH = 0.3194 \cdot (2LSM1 + LSM4) \quad (6.76)$$

$$GYR = \frac{K_{YY}}{LSMH} + Gyradius_inc \quad (6.77)$$

Adjustments are made to the base gyradius according to the following recorded characteristics of the yacht:

1. If Mast Weight (*MWT*) and Mast Center of Gravity (*MCG*) have been recorded, the gyradius contribution of the mast is assessed as compared to that of a hypothetical base aluminum mast (Default mast weight – *DMW*) and a corresponding mathematical gyradius adjustment is made; since 2019 this mast gyradius adjustment term is then multiplied by 0.5;

Default Mast Weight:

$$DMW = (((.00083 \cdot IG \cdot (IG + HBI)) + (.000382 \cdot IG \cdot TML))) \cdot (YP)^{0.5} \quad (\text{lbs})$$

Default Mast VCG:

$$DMVCG = 0.415 \cdot (IG + P + BAS) / 2 - BAS \quad (\text{ft above BAS})$$

Default Rigging Weight:

$$DRW = LRW + JRW \quad (\text{lbs})$$

Default Rigging VCG:

$$DRVCG = (0.372 \cdot IG \cdot LRW + 0.5 \cdot (P + BAS + 0.85 \cdot IG) \cdot JRW) / DRW - BAS \quad (\text{ft above BAS}).$$

Default Mast+Rigging Weight:

$$DMW + DRW \quad (\text{lbs})$$

Default Mast+Rigging VCG above BAS:

$$(DMW \cdot DMVCG + DRW \cdot DRVCG) / (DMW + DRW) (\text{ft}).$$

where:

LRW (Lower Rigging Weight) = $0.000155 \cdot IG \cdot YP$ (lbs)
 JRW (Jumpers Rigging Weight) = $0.000027 \cdot (P + BAS - 0.85 \cdot IG) \cdot YP$ (lbs) (0 for masthead)
 $YP = (((RM25 \cdot 25) + CARM \cdot CW \cdot \cos(25^\circ)) / (CP/2))$
 TML (Top Mast Length) = 0 on masthead and $P + BAS - IG$ on fractional
 $RM25$ = Righting Moment per degree at 25 degrees of heel
 $CARM$ = Crew Righting Arm
 CW = Crew Weight
 CP = Calculated Chainplate Width : $\max(0.46 \cdot J, 0.135 \cdot IG)$
Masthead is defined as a rig with $IG \geq 0.95 \cdot (P + BAS)$.

2. For estimate a yacht with a carbon mast, where MWT and MCG are not recorded, the base gyradius shall be adjusted taking as mast weight:

$$MWT = DMW \cdot SQRT(70000/170000)$$

The mast weight for carbon mast is decreased of the square root of the ratio of the Young Modulus of aluminum (70000 Mpa) and that of a very high modulus carbon mast (170000 Mpa) If the boat is fitted with fiber rigging (PBO, carbon or similar) the rigging weight will be taken as: Rigging Weight = $0.2 \cdot DRW$, being 20% of a conventional normal rod rig the weight of an aggressive fiber weight.

3. Where MWT and MCG are not recorded, the number of spreader sets (including jumpers –one or zero), adjustable inner forestays and running backstays (see 810.2I) are totaled. Gyradius is increased by 0.002 multiplied times the number by which the above total is less than 6. This total is not taken less than zero;
4. If a yacht has a mizzen mast, Gyradius is increased by 0.002.
5. If the yacht has Forward Accommodation, $FWDADJ = 0.004$ (see 9 below);
6. If the yacht's rudder construction is carbon fiber, 0.003 is subtracted from Gyradius;
7. If the yacht is in the cruiser/racer division and complies with IMS Appendix 1, $C/R_ADJ = 0.006$ (see 8 below);
8. Any FWD ADJ (5 above) and any C/R_ADJ (7 above) shall be added together and the sum reduced according to an indicator of performance potential, i.e., sail area /volume ratio. The resulting Accommodation Gyradius Increment is calculated as follows:

$$ACC_GYR_INCR = (C/R_ADJ + FWD_ADJ) \cdot ((0.6763 \cdot L + 19.6926 - SA/VOL) / (0.2263 \cdot L + 2.6926)).$$

The term multiplying $(C/R_ADJ + FWD_ADJ)$ shall be neither negative nor greater than 1.0.

$$SA/VOL = (AREA_MAIN + AREA_GENOA) / (DSPA/1025)^{2/3}.$$

ACC_GYR_INCR is added to Gyradius.

9. If there is light material such as titanium or carbon used in lifeline elements (stanchions, pulpits, pushpits, etc.) or if they are not present the $gyrad_inc_fraction_of_L$ is decreased by 0.005.

CRUISER/RACER PITCH GYRADIUS ALLOWANCE SCHEME

This credit scheme is intended to allow for the greater pitching inertia of boats that race with anchor and chain in the bow (anchor and chain should be located in the forward 30% of the boat and should be lodged in forepeak fully reachable from deck).

The total gyradius increment due to the anchor and chain shall not be taken as more than 0.013. The gyradius increment will be added to the gyradius derived in.

6.9 CONSTRUCTION MATERIAL LENGTH FACTOR

In 2017 the approach to the construction material changed. Before, a credit or penalty were given in terms of gyradius. The ITC agreed in removing the gyradius credit or penalty because in recent years the weight saved by a light construction is placed down in the bulb and no more in the bilge. Therefore it's not obvious that the masses are more concentrated around the center of gravity and that the gyradius decreases.

<i>Construction</i>	<i>Length Factor</i>
CARBON	1.000
LIGHT	0.995
CORED	0.990
SOLID	0.985

TABLE 6.4: *Length factor for construction material*

On the other hand, a stiffer material makes the boat stiffer. This means that it keeps longer when the forestay is in tension, bending less. Following this argument, a length factor is applied only upwind, based on the construction material. The length used to enter in the Fn-Residuary Resistance tables is shortened based on the construction material as shown in Table 6.4

7 ENVIRONMENT

7.1 WIND TRIANGLE

The wind triangle relationships as implemented in the VPP include the effects of heel and the assumed wind gradient. The VPP resolves the total aerodynamic force relative to the fore and aft center plane of the mast, a lift force normal to it and a drag force in the plane of the mast. Therefore in order to introduce the effect of heel the true wind vector is modified as follows.

First, the true wind vector is resolved into components perpendicular and parallel to the yacht's velocity vector. Only the perpendicular component is multiplied by the cosine of the heel angle. To account for the variation in true wind velocity with height, both components are multiplied by a factor representing this change. Once this is done, the now modified True wind vector can be used in the normal vector analysis to yield the apparent wind vector at the centre of effort of the sails.

$$V_{Tz} = V_{Tzref} \cdot \frac{\log\left(\frac{z}{z_0}\right)}{\log\left(\frac{z_{ref}}{z_0}\right)} \quad (7.1)$$

where¹

$$\begin{aligned} z &= \text{height above water plane} \\ z_{ref} &= 10.0 \text{ m, reference height for } V_T \text{ measurements} \\ z_0 &= 0.005 \text{ m} \end{aligned}$$

The apparent wind angle (β_A) is calculated from the following formula.

$$\beta_A = \tan^{-1} \left(\frac{V_T \cdot \sin \beta_T \cdot \cos \phi}{V_T \cdot \cos \beta_T + V_s} \right) \quad (7.2)$$

The corresponding apparent wind speed (V_A) is calculated as follows.

$$V_A = \sqrt{(V_T \cdot \sin \beta_T \cdot \cos \phi)^2 + (V_T \cdot \cos \beta_T + V_s)^2} \quad (7.3)$$

7.2 SAILING ANGLES

The VPP calculates the sailing speed at the following true wind angles and wind speeds:

TWS:	6	8	10	12	14	16	20											
TWA:	vmgup	52	60	70	75	80	90	110	120	135	150	165	180	vmgdn				

The calculations are done for the upwind sails (mainsail and jib) and downwind for the mainsail with each declared off wind sail type.

The results are polar curves for each true wind speed, and the program then chooses the sail combination to produce best speed and uses this in the table of handicaps.

7.2.1 VELOCITY MADE ALONG THE COURSE. (VMC)

The VMC² concept is similar to the VMG for upwind or downwind sailing. The goal is to reach the mark, which is at an hypothetical prescribed heading, in the minimum time. This is accomplished sometimes by a course different

¹the reference value of z_0 has been modified in 2022, from 0.001 to 0.005: published data suggest that the big majority of races take place in venues where the wind profile is better described by a more stable and thick boundary layer, therefore using a z_0 value of 0.005. This has the effect of reducing wind velocities at lower levels.

²2011

from the straight, shortest one. Sometimes a course made of two legs, one closer to the wind and the other farther from it, is faster than the direct one. The implementation of this concept is made by calculating the best VMC for the (TWS, TWA) printed in the certificate, but using a splined continuous polar of the best performance of the boat evaluated at two degree intervals.

8 HANDICAPPING

8.1 VPP RESULTS AS USED FOR SCORING

8.1.1 VELOCITY PREDICTION

All the calculations performed by LPP and VPP after taking into account Dynamic and Age allowances are eventually used in calculations of speed predictions for 7 different true wind speeds (6-8-10-12-14-16-20 knots) and 8 true wind angles (52° – 60° – 75° – 90° – 110° – 120° – 135° – 150°), plus the 2 “optimum” VMG (Velocity Made Good) angles: beating ($TWA = 0^\circ$) and running ($TWA = 180^\circ$), which are calculated obtaining an optimum angle at which the VMG is maximized. The calculations are done for the upwind sails (mainsail and jib or headsail set flying) and downwind for the mainsail with each declared largest off wind sail type (symmetric, asymmetric on pole, asymmetric on centerline and headsail set flying), where the program then chooses the sail combination to produce best speed.

Rated boat velocities in knots							
Wind Velocity	6 kt	8 kt	10 kt	12 kt	14 kt	16 kt	20 kt
Beat Angles	42.8°	41.3°	40.9°	39.8°	39.0°	38.3°	38.3°
Beat VMG	4.06	4.88	5.38	5.64	5.77	5.87	5.98
52°	6.20	7.32	7.87	8.08	8.19	8.25	8.39
60°	6.58	7.64	8.10	8.31	8.42	8.49	8.62
75°	6.91	7.87	8.29	8.55	8.75	8.88	9.03
90°	7.11	8.07	8.50	8.80	9.08	9.28	9.64
110°	6.87	7.95	8.46	8.87	9.33	9.78	10.55
120°	6.50	7.73	8.36	8.80	9.29	9.75	10.72
135°	5.77	7.09	7.99	8.48	8.91	9.44	10.69
150°	4.85	6.01	7.10	7.94	8.42	8.83	9.85
Run VMG	4.20	5.21	6.14	6.94	7.58	8.17	8.99
Gybe Angles	141.5°	146.5°	149.0°	155.0°	166.0°	180.0°	180.0°

TABLE 8.1: Velocity prediction printed on the 1st page of the ORC International certificate

8.1.2 TIME ALLOWANCES

The unique feature of ORC Rating system, making it fundamentally different from any other handicap system and much more precise, is its capacity to give and rate different handicaps for different race conditions because yachts do not have the same performance in different conditions. For example, heavy under-canvassed boats are slow in light airs but fast in strong winds. Boats with deep keels go well to windward and light boats with small keels go fast downwind.

This means that yachts will have a variable time allowance in any race depending on the weather conditions and the course configuration for that particular race as managed by the Organizer.

For the purpose of the Performance Curve Scoring as defined in the ORC Rating Rule 402, velocity predictions are also expressed as time allowances in s/NM where $TA = 3600/v$.

From the time allowances calculated for 9 wind angles and 7 wind speeds, two types of pre-selected courses are also available:

1. **Windward/Leeward** is a conventional course around windward and leeward marks where the race course consists of 50% upwind and 50% downwind legs;
2. **All Purpose** (formerly named Circular Random) is a hypothetical course type in which the boat circumnavigates a circular island with the true wind velocity held constant;

Time Allowances in secs/NM							
Wind Velocity	6 kt	8 kt	10 kt	12 kt	14 kt	16 kt	20 kt
Beat VMG	886.1	737.6	668.8	638.7	624.4	613.1	601.9
52°	580.2	491.6	457.4	445.4	439.6	436.4	428.8
60°	547.3	471.5	444.5	433.2	427.6	424.2	417.6
75°	520.8	457.5	434.5	421.0	411.5	405.4	398.8
90°	506.5	446.2	423.6	409.0	396.6	387.9	373.3
110°	524.0	452.6	425.6	405.9	386.0	368.1	341.2
120°	553.7	465.9	430.7	409.0	387.5	369.2	335.7
135°	623.5	508.0	450.3	424.7	403.8	381.5	336.9
150°	742.8	598.6	507.4	453.6	427.5	407.6	365.5
Run VMG	857.7	691.2	585.9	518.5	474.9	440.9	400.2
Selected Courses							
Windward / Leeward	871.9	714.4	627.3	578.6	549.7	527.0	501.1
All purpose	663.6	554.7	501.3	472.7	454.4	438.9	416.9

TABLE 8.2: Time Allowances and Selected Courses on the second page of the ORC International certificate

WIND AVERAGING

When calculating the GPH, the “wind averaging” operator is applied to the all purpose course, that smooths the individual performance curves for each yacht, taking into account not only each considered wind speed as calculated by the VPP, but a normal distribution across the range that accounts for the 23.58% of the accounted wind speed, 19.8% for 2 kts above and below, 11.73 for +-4 kts, 4.89 for +-6 kts, and 1.79 for +-8 kts.

The wind averaging is not used for the constructed course method.

8.2 SIMPLE SCORING OPTIONS

ORC International and ORC Club certificates are also providing simple scoring options using the ratings determined as a single number. The first number is GPH (General Purpose Handicap), which is as an average representation of all time allowances for simple comparisons between boats and possible class division. It is calculated as an average of the time allowances of 8 and 12 knots true wind speed for the all purpose course.

Then two basic simple scoring options are offered in the ORC certificate by default: the *All Purpose* and the *Windward/Leeward*.

Single Number Scoring Options		
Course	Time On Distance	Time On Time
Windward / Leeward	601.8	0.9971
All purpose	486.3	1.2338

TABLE 8.3: Simple scoring options on ORC International & ORC Club certificate

8.2.1 TIME ON DISTANCE (TOD)

$$\text{Corrected time} = \text{Elapsed time} - (\text{ToD}_{\text{Delta}} \times \text{Distance}) \quad (8.1)$$

where

$$\text{ToD}_{\text{Delta}} = \text{ToD}_{\text{Boat}} - \text{ToD}_{\text{Lowest}} \quad (8.2)$$

$\text{ToD}_{\text{Lowest}}$ is the lowest coefficient in the fleet (that of the fastest, scratch boat). The scratch boat will have a corrected time equal to its elapsed time.

The All Purpose and Windward Leeward Time on Distance coefficients are calculated as a weighed average over wind speeds of the handicaps of the respective course model (all purpose or windward leeward). The weights for each wind speed are as follows:

TWS (kt)	6	8	10	12	14	16	20
weight (%)	5	10	20	30	20	10	5

8.2.2 TIME ON TIME (TOT)

$$\text{Corrected_time} = \text{ToT} \times \text{Elapsed_time} \quad (8.3)$$

Time on Time coefficients are calculated as 600/ToD.

8.2.3 TRIPLE NUMBER

$$\text{Corrected_time} = \text{ToT}(\text{Low, Medium or High}) \cdot \text{Elapsed_time} \quad (8.4)$$

Triple number scoring coefficients are given are given for three wind ranges:

1. Low range (less than 9 knots)
2. Medium range (equal or more than 9 but less than 14 knots)
3. High range (14 or more knots)

The ToT's displayed on the certificate are derived as follows. The three wind velocity ranges (High, Medium, Low) are each comprised of weighted averages of several Time Allowances (s/NM) selected from the familiar seven ORC wind speeds. The "cookbook" recipe for proportions in each of the three wind ranges is given in Table 8.4. The result is a form of wind-averaging for each of the three Triple Number wind ranges:

Wind Speed:	6 kt	8 kt	10 kt	12 kt	14 kt	16 kt	20 kt
Low Range	50.0 %	50.0%					
Med Range		8.33%	33.3%	33.3%	25.0%		
Hi Range					25.0%	37.5%	37.5%

TABLE 8.4: Time allowance weighing table

Once a single weighted average sec/mi Time Allowance has been calculated for each of the three wind ranges, these are converted to a ToT by the formula $\text{ToT} = 600/\text{TA}$.

Offshore Triple Numbers coefficients are calculated using time allowances for the Circular Random type of pre-selected course.

Inshore Triple Numbers coefficients are calculated using time allowances for the Windward/leeward type of pre-selected course.

8.2.4 CLASS DIVISION LENGTH (CDL)

In 2014 ITC noted two fundamental issues related to class divisions based on GPH:

1. the low possibility to design fast yachts in lower divisions without being compelled to make them too small to fit in the GPH limits. The consequence is that the winners of the lower divisions are always medium/heavy displacement boats, usually the largest in their class.
2. the first windward leg of the inshore races is a fundamental part of the race and it should be better to have as many boats as possible with similar windward speed in the same class.

In the past, to solve the first issue the smallest boats of the larger class were moved according to a fixed length limit, or conversely pushed up into the larger class with boats exceeding a certain length, but this caused complaints.

To answer the second issue, ITC decided to select the Windward12 (UP 12) handicap instead of using GPH to group boats with similar upwind speeds into the class. To also maintain similar dimensions it was decided to couple the windward speed at TWS=12 kts with the sailing length (IMS L) of each boat.

To couple the two factors (UP12 and IMS L) it was decided to transform the WW12 allowance (that is a speed) in a length and average the obtained length with IMS L. The final factor was named CDL (Class Division Length)

The transformation in length of the UPWIND12 allowance is obtained with the following formulation:

$$VMG_{UP12} = \frac{3600}{UP12} \cdot 0.5144 \quad \text{where } VMG_{UP12} \text{ is boat upwind speed in m/s at 12 kts wind}$$

$$RL = \frac{VMG_{UP12}^2}{Fn^2 \cdot 9.81} \quad \text{where } RL \text{ is rated length and } Fn \text{ is Froude number set at 0.28}$$

The RATED LENGTH is the length that you should have at $Fn = 0.28$ with the VMG_{UP12} speed, so it is transforming a speed into a length. Froude number of $Fn = 0.28$ for upwind VMG was fixed using $Fn=0.4$ (that is the Froude number at around which maximum displacement speed is obtained) multiplied by $\cos(45^\circ)$, 45° being the average true wind angle upwind.

The Class Division Length is then calculated as follows:

$$CDL = \frac{IMSL + RL}{2} \quad (8.5)$$

The CDL, coupling a speed (or a handicap in sec/mi) and a length, is addressing the problem of mixing handicap and dimensions of boats returning more homogenous classes in terms of dimensions and speed.

APPENDIX A OFFSETS FILE (.OFF) FORMAT

A.1 INTRODUCTION TO OFFSET FORMAT 2.0

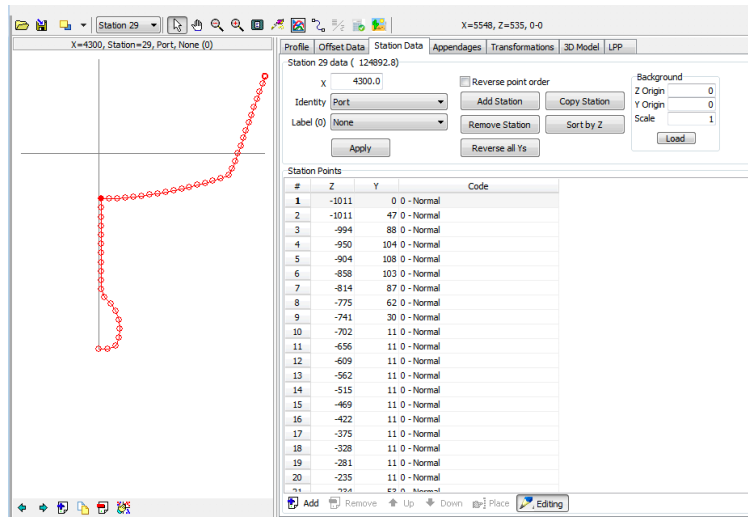

FIGURE A.1: Offsets editing through ORC-Manager application

The traditional offset file format (see below for a detailed description) has been changed in 2021, and a new XML format has been designed. This gives the flexibility of adding new features to the offsets file, like a more detailed description of appendages and superstructures.

The user interacts with the offset file by means of the ORC Manager software, that is handling the user interface offered for any editing and change to the hull and appendages.

The transition from old to new format is transparent to the user: once an offsets file will be modified, it is saved by default in the new format.

A.2 OFFSET FORMAT - PRE 2021

Offset file describes the shape of the hull together with appendages as a sequence of point measurements arranged in transverse stations. Points along the selected stations are taken from the bottom up with an ORC approved hull measurement device capable to produce a list of the points in the co-ordinate system as follows:

1. X axis – longitudinal with 0 at stem and positive towards the stern
2. Y axis – transverse with 0 at the centerline and positive towards the beam
3. Z axis – vertical with 0 at an arbitrary waterline and positive upwards

Stations are taken at 5% intervals, doubled to 2.5% in the front 15% of the hull. The measurements taken on port and starboard sides are collapsed in the OFF file as if they were on a single side, but they are identified by a station code, which is 1 for starboard and 2 for port. Freeboard stations are measured from both sides. Appendages such as keel and rudder are measured along transverse stations as any other, and extra stations need to be placed at any vertex of appendage in its profile.

Moveable appendages as centerboards, daggerboards and bilgeboards if fitted, don't need to be measured. There is a maximum limit in the LPP of 180 points per station and 180 stations. The LPP may add points and stations internally.

Units may be in decimal feet*100, or integer millimeters.

OFF file is an ASCII file format with the fields separated by commas and in the required character positions as follows:

First 4 lines are header with general hull data as follows:

```
HH:MM:SS, DD/MM/YY,MEAS#,MACH, FILE,CLASS ,1MYY
0.000, 0.000, 0.000, 0.000
0.000, 0.000, 0.000, 0.000
NST, LOA , SFJ, SFBI
```

LINE 1

Label	Columns	Explanation
HH:MM:SS	1-9	Time of measurement
DD/MM/YY	11-20	Date of measurement
MEAS#	22-26	Measurers code
MACH	28-31	Machine code. (If ≤ 0 measurements are in ft*100)
FILE	33-39	File name
CLASS	41-64	Class
1MYY	66-70	Age date with month and year. "1" in front is added for 2000 and following years

LINE 2&3 (METRIC SYSTEM)

```
SFFPs, FFPVs, SAFPp, FAPVs
SFFPp, FFPVp, SFFPs, FAPVp
```

Label	Columns	Explanation
SFFPs, SFFPp	1-8	Distance from stem to the forward freeboard station (port & starboard)
FFPVs, FFPVp	10-16	Vertical distance from the forward freeboard station uppermost point to the sheerline where sheer point can not be taken (port & starboard)
SAFPs, SAFFPp	18-24	Distance from stem to the aft freeboard station (port & starboard)
FAPVs, FAPVp	26-32	Vertical distance from the forward freeboard station uppermost point to the sheerline where sheer point can not be taken (port & starboard)

LINE 2&3 EXPLANATION (US OPTION)

```
-99, FFLAP, FALAP, FGOLAP
LBGLAP, KLEPFG, dummy, dummy
```

In this alternative format that is associated with a number of HMI US machines in line 2 field 1 is a negative number, which means also that measurements are in ft*100. This is followed by IOR existing freeboard measurements and locations, and the "wing keel" indicator, that usually is defined by a code "4" applied in the wing/bulb widest point. This is obsolete after 2005 due to a different treatment of the wing/bulb keel aerodynamics. The last 2 fields of line 3 are just spare in this optional formatting.

LINE 4

Label	Columns	Explanation
NST	6-8	Number of stations
LOA	10-16	Length overall
SFJ	18-24	Distance from the stem to the forward end of J
SFBI	26-32	Stem to mast distance, SFJ + J. This is used to locate the mast to get HBI (Height of sheer at the Base of I).

Note: SFJ and SFBI are set to zero in most files and are not relevant.

STATIONS DEFINITIONS

The stations are arranged from bow to stern (increasing X) regardless of being port or starboard. The first station should be placed so the stem of the yacht is at $X=0.0$. X should never be a negative number. Stations should be taken so that a plot in elevation view of the bottom points of the stations defines all discontinuities in the underwater profile. Stations are needed at all knuckles, where the keel and rudder meet the canoe body, the bottom corners of the keel, bulb and rudder. The maximum thickness of the appendages should also be defined, and a double station in way of the keel is recommended. A station should be taken close to the stem and the extreme aft end of the boat.

Line 5 and the following lines contain information about each section in the following sequence:

```

X,NPT,SID,SCD,sta#
Z(1),      Y(1),PTC
Z(2),      Y(2),PTC
Z(3),      Y(3),PTC
Z(4),      Y(4),PTC
...
...
Z(NPT),    Y(NPT),1

```

FIRST LINE OF EACH STATION

Label	Columns	Explanation
X	1-10	Distance from the stem for each station in millimeters for metric units, in hundredths of feet for imperial units
NPT	12-14	Number of points in a section. Important to be correct.
SID	16-18	Side code: 1-Port; 2-Starboard; 3-Both
SCD	20-22	Station label: 1-Forward freeboard; 2-Aft freeboard; 3-Station contains prop shaft exit point; 4-Station contains propeller hub point
sta#	24-27	Station count, not necessary, but included for convenience

STATION POINTS DEFINITION

Label	Columns	Explanation
Z(n)	1-10	Vertical co-ordinate for points on a half section, positive up, negative down in millimeters for metric units, in hundredths of feet for imperial units
Y(n)	11-21	Horizontal distance from the centerline for points on a half section. Negative only in the gap in section for example, between the canoe body and the trailing edge where point code PTC is set to 2.
PTC	23-25	Point code as explained below

POINT CODES:

- 0 - Normal hull point.
- 1 - Sheer point. If no point on a station has a point code of 1, the top point on the station becomes the sheer point.
- 2 - Poke-through (empty space in a gap bounded by the point immediately above and below. More commonly represented by a Y (transverse offset) of less than -0.3 feet.
- 3 - Propeller or shaft exit point (the appropriate station code having already been entered).
- 4 - Maximum width points of a wing keel.
- 5 - US measurement machine centerline points (has no rating effect).
- 6 - Propeller aperture bottom point (may exist in some old US offset files).
- 7 - Propeller aperture top point (may exist in some old US offset files).
- 8 - Poke-through on the leading edge of an appendage. Most of the time, the program can decide automatically if one or more stations with poke-throughs are leading or trailing edge. If an appendage with leading edge poke-throughs plots incorrectly, this may help.
- 9 - Poke through on the trailing edge of an appendage. If an appendage with trailing edge poke-throughs plots incorrectly, this may help.
- 10 - Poke-through in a closed hole through an appendage. There is no automatic recognition of holes.
- 11 - Poke-through in a contiguous set of stations that all have poke-throughs which completely sever the appendage from the hull. This code will limit the appendage profile to only those points below the poke-throughs.
- 12 - Do NOT clip at this specific point. Use on points which are the inside corner of a left turn while scanning down the section. This is typically used to prevent clips at hard chines with lips or lapstrake type construction.
- 13 - Prevent clipping of entire stations narrower than 3 percent of BMAX by setting this code on any point in the station. This would be typically used on the very tip of a transom that comes to a point. This code will not prevent a clip at a left turn or poke through in the station.
- 14 - If this code is set on any point in the station, you force clipping of the entire station even though it may be wider than 3% of BMAX, and regardless of any poke-throughs and left turns.
- 15 - Do not clip this station in any way, either entirely or at any point if this code is set on any point in the station.
- 16 - Force a clip at this point.

DOUBLE RUDDER

Data on the double rudder are entered as an extra input line in the .OFF file. Data input can be made by means of the ORC Manager application.

r_yoff	r_xoff	r_span	r_chordroot	r_chordtip	r_thicknessroot
Y offset	X offset	Rudder Span	Root Chord	Tip Chord	Root thickness
r_thicknesstip	Angle y_off	r_xoff	angle		
Tip Thickness	the stagger from CL of the root. if =0 means single rudder.	longitudinal position of centroid.	lateral inclination angle compared to vertical		

APPENDIX B NEURAL NETWORKS FOR RR MODEL

```
! Inputs
'FN' 'LVR' 'LVR4' 'LVR6' 'BTR' 'LSMIRATIOXYA' 'LSM4RATIOXYA' 'LSMIRATIOXYB' 'LSM4RATIOXYB' 'X_MAX_SECT_AREA' 'LCB' 'LCF' 'CWPA' 'CM'
! Output
'CALC_CFXP_FN_Fz_LPP22t105c'

! ZeroToOne Normalisation - Min, Max & Range for Inputs and Output
FN 1.67909234e-01 8.96221954e-01 7.28312721e-01
LVR 3.90947706e+00 1.16767453e+01 7.76726822e+00
LVR4 4.22797313e+00 1.14408424e+01 7.21286928e+00
LVR6 4.07377654e+00 1.13164475e+01 7.24267095e+00
BTR 2.98954359e+00 1.24914805e+01 9.50193692e+00
LSMIRATIOXYA 4.48110341e-04 1.85271438e-02 1.80790335e-02
LSM4RATIOXYA 6.43066887e-04 2.4964347e-02 2.43533679e-02
LSMIRATIOXYB 3.83449491e-04 1.48579710e-02 1.44745215e-02
LSM4RATIOXYB 4.92337345e-04 2.06654917e-02 2.01731543e-02
X_MAX_SECT_AREA 3.92942871e-01 8.68918217e-01 4.75975346e-01
LCB 4.41800000e-01 6.29000000e-01 1.87200000e-01
LCF 4.82100000e-01 6.31200000e-01 1.49100000e-01
CWPA 5.73580613e-01 7.59591957e-01 1.86011344e-01
CM 5.26353401e-01 8.58372510e-01 3.32019109e-01
CALC_CFXP_FN_Fz_LPP22t105c 8.15859570e-03 3.59103310e-01 3.50944715e-01

! Number of layers including input and output layers
5
! Array of neurons including input and output layers. Length of array = number of layers
14 8 5 3 1
! Activation Functions (for each layer)
None Tanh Tanh Tanh None

! Weights (for each layer)
Layer 0
None
Layer 1
-3.12366269e+00 1.87806362e+00 6.08975457e-01 1.42324325e+00 -1.55170939e+00 1.26114391e+00 6.43186669e-01 6.30489430e-01 -2.10445727e+00 3.64699203e+00 2.71808252e+00 -4.41458820e-01 -3.94703559e-01 -2.94062018e-01
-8.39375199e-01 1.56655533e+00 -2.99796065e-01 -5.03040166e-01 3.22457764e-01 4.37107871e-01 -1.11808409e-01 6.76998112e-01 -7.13558431e-01 6.20025954e-02 -7.64400366e-01 -2.23413629e-01 -2.44977612e-01 5.11021788e-02
-3.40512318e-01 -1.04284591e-01 5.66341662e-01 7.56305394e-01 2.00618906e-01 1.34834046e-01 1.09667038e+00 -6.60914495e-01 -1.37293552e+00 4.93650131e-01 -1.06044935e+00 3.69543223e-01 5.15648499e-02 9.96790431e-01
5.68163814e-01 -2.19403291e+00 -1.78454619e-04 9.91364761e-01 -2.90490703e-02 -4.25947350e-01 -5.13784320e-01 4.19041714e-01 5.99293719e-01 3.62755170e-01 6.03007822e-02 -5.85437312e-01 8.23660148e-01
-4.7332542e-01 4.38444498e-01 -2.27444600e-01 1.16452298e-01 1.69340734e-01 -1.07176039e+00 -7.53193343e-01 -1.26965760e-01 1.36629325e+00 -2.43807542e-01 1.17243438e-01 7.11990265e-02 4.54235964e-01 -2.26236014e-01
-2.44225200e+00 -5.16970478e-01 2.34764154e-01 7.52296256e-01 -2.29627303e-02 -2.59925536e-01 3.26600133e-01 -3.52710941e-01 -4.87748027e-01 -9.60156277e-02 1.11912448e-01 2.61352321e-01 6.29272959e-01 -1.69407355e-01
1.75741026e+00 1.38149390e+00 4.74126756e-01 5.6085659e-01 4.28263949e-01 -1.00261812e-02 -7.27809585e-01 8.35159161e-02 3.86668310e-01 -2.87708632e-01 -2.63686399e-01 1.78814068e-01 3.57605342e-01 -1.50234883e-01
-7.72814360e-02 1.68582572e-01 -7.87451319e-01 -9.17650980e-01 -3.96990913e-01 -2.04754717e-01 -8.28368591e-01 -5.34497439e-01 4.36333227e-01 6.68097760e-01 5.13402345e-01 1.01582747e-01 4.18329772e-01 4.50615493e-01
Layer 2
-1.41183914e+00 -3.71733419e-01 -5.73865836e-01 1.23080650e+00 -2.24716020e-01 1.31476157e+00 -7.67259093e-01 -7.23743149e-01
-1.72672226e+00 5.87167919e-01 -2.71595517e-01 -7.02012120e-01 -3.60586413e+00 -1.43241136e+00 7.72083877e-02 1.56733998e+00
1.09005701e+00 2.90876917e-01 1.11845108e+00 -7.00848545e-01 9.50337020e-01 -5.90830615e-01 -6.71009271e-01 -6.36013053e-01
4.00228913e-01 1.20447505e+00 -9.29017538e-01 1.30716539e+00 -1.17515688e+00 2.85614776e+00 -5.80772912e-01 -3.61857262e-01
-5.08374126e-01 9.73997548e-01 -8.79276355e-01 1.34942149e+00 1.01328999e+00 5.70766725e-01 -2.68571863e-01 2.11901367e-01
Layer 3
-9.43271327e-01 9.29636646e-01 -8.38423143e-01 -7.43597322e-01 -6.87171406e-01
2.25094386e-01 5.06835735e-02 3.73732948e-01 4.87776940e-01 -4.28992317e-01
-6.10921621e-01 -4.04964126e-01 1.89997727e-01 5.38191449e-01 1.27954238e+00
Layer 4
5.37231432e-01 -4.26556958e-01 6.68605258e-01

! Biases (for each layer)
Layer 0
None
Layer 1
-5.98025268e-01 9.74903913e-02 -2.11881042e-01 -3.19691451e-02 -7.37131232e-02 7.64130445e-01 -5.76838678e-01 -3.66612790e-01
Layer 2
-3.20300803e-01 -1.83107893e-01 1.43053535e-01 -3.46000046e-01 1.08191809e+00
Layer 3
5.98378322e-02 3.51013480e-01 2.53590339e-01
Layer 4
1.51104400e-01
```

```

I Inputs
I 'FN' 'LVR4' 'LVR6' 'BTR' 'LSMRANTOXVA' 'LSMRANTOXVA' 'LSMRANTOXVA' 'LSMRANTOXVA' 'X_MAX_SECT_ARBA' 'LCP' 'LCP' 'CPVA' 'CM'
I Output
I CMC_CFP2_FN_FZ_DEP221105C'

I ZeroToOne Normalisation - Min, Max & Range for Inputs and Output
FN 1.6790234e-01 8.7622193e-01 7.2821272e-01
LVR4 1.2229713e-00 1.1480842e-01 7.2128629e-00
LVR6 4.0727765e-00 1.1316447e-01 7.2426709e+00
BTR 2.9895453e+00 1.24914805e-01 9.50193692e+00
LSMRANTOXVA 4.1481031e-04 1.85271438e-02 1.80790335e-02
LSMRANTOXVA 6.43066887e-04 2.49664347e-02 2.4353679e-02
LSMRANTOXVA 3.8349491e-04 1.48579170e-02 1.44745215e-02
LSMRANTOXVA 4.92317345e-04 2.0665917e-02 2.01731513e-02
LSMRANTOXVA 3.9294871e-04 8.68918217e-01 4.75975346e-01
X_MAX_SECT_ARBA 1.99999999e-01 6.31200000e-01 1.49100000e-01
LCP 4.43210000e-01 6.31200000e-01 1.49100000e-01
CPVA 5.77380613e-01 7.59591957e-01 1.86011344e-01
CM 5.2653401e-01 8.58372510e-01 3.32019109e-01
CMC_CFP2_FN_FZ_DEP221105C 8.15859570e-03 3.5910310e-01 3.50944715e-01

I Number of Layers Including Input and Output Layers
5

I Array of neurons including input and output layers. Length of array = number of layers
1 4 8 3 1
I Activation Functions (for each layer)
None Tanh Tanh None
None
I Weights (for each layer)
None
Layer 1
2.11105233e+00 3.25703271e-01 3.45560518e-01 -6.67676599e-02 2.21418064e-02 -2.71131212e-01 -6.12939301e-01 -1.84733695e-01 -2.24792310e-01 -1.54139789e-01 3.65845414e-01 2.96228868e-01 6.72597001e-01 -1.91577873e-01
-6.34910561e-01 -7.19922144e-02 -5.38400285e-01 -5.83049408e-01 -2.05348071e-01 -3.883234427e-01 -2.07773338e-01 3.74354413e-02 6.93521122e-02 9.44355028e-02 -1.48754439e-01 -9.39069948e-01 4.76380156e-01 -1.03454548e-01 -5.97588796e-02
8.3866682e-03 -1.07522707e+00 2.33436950e-01 8.31909570e-02 6.74458918e-01 1.154450017e-01 4.81661375e-01 2.13271310e-01 2.87573036e-01 -5.93621893e-01 1.36215996e+00 8.71674249e-01 4.18879485e-02 1.34230058e-01 -2.59594741e-01
-1.91073767e+00 8.16336810e-01 9.26462719e-01 9.2836177e-01 -8.0923797e-01 -1.32446073e-01 3.44262895e-01 -2.87573036e-01 2.96776595e-01 1.88816347e-01 -5.49702755e-01 -8.65037789e-01 4.28012338e-01 5.11794619e-02 8.6230028e-01
-2.87892423e+00 -6.4167442e-01 -6.31147289e-01 -4.23244499e-01 8.64676094e-01 -1.57059506e-01 2.75842190e-01 2.96776595e-01 3.78895688e-01 -1.88816347e-01 -5.49702755e-01 -1.8038443e-01 -1.65277294e-01 -2.13454245e-01 -4.47050774e-01 6.82731778e-02
-5.65026486e-01 6.35220080e-02 2.16805399e-02 1.82444521e-01 -9.90467618e-01 -4.12342740e-01 -1.78918395e-02 -3.78895688e-01 -3.79299844e-01 -1.91743512e-01 -1.91743512e-01 1.65277294e-01 -2.13454245e-01 -4.47050774e-01 6.82731778e-02
-2.16706434e+00 -9.4316139e-01 -2.52380806e-01 -9.15337273e-02 -2.83059590e-01 3.78921479e-01 7.28584457e-02 7.91893785e-02 -1.18038443e-01 -5.61321866e-01 -2.88088971e-01 4.87206703e-01 -4.87206703e-01 -1.03578696e+00 -2.60319036e-01
1.101119651e+00 -5.4316139e-01 -2.52380806e-01 -9.15337273e-02 -2.83059590e-01 3.78921479e-01 7.28584457e-02 7.91893785e-02 -1.18038443e-01 -5.61321866e-01 -2.88088971e-01 4.87206703e-01 -4.87206703e-01 -1.03578696e+00 -2.60319036e-01
I 0.9976951e-01 4.03591889e-01 2.70916791e-02 -1.18659167e+00 -8.95300255e-01 -4.9562551e-01 -1.04232987e+00 -1.96913435e-01
-2.68093464e-02 7.0884742e-01 -2.7959484e-01 -5.72978199e-01 8.60595788e-02 2.75027848e-01 8.47863508e-01 -5.59275851e-01
9.40527667e-01 4.34408709e-02 1.61131269e-01 -2.6085907e-02 -4.70232850e-01 -1.22988542e+00 -7.72810004e-01 -5.47735266e-01
1.2904689e+00 -6.55517920e-01 2.96516404e+00 -1.61893540e-01 -4.9468251e-01 4.26717304e-01 4.26717304e-01 -5.78575949e-02 -8.13683090e-01
-1.40527533e-01 9.65888051e-01 2.33779299e-01 4.93501601e-02 -5.20447102e-01 -2.10844807e-01 4.66705453e-02 -2.32629377e-01
Layer 3
-2.9305058e-01 -1.08946587e+00 1.03661012e+00 6.46001374e-01 -6.26314458e-01
-1.2121932e+00 8.34889324e-01 -7.80687821e-01 3.73101071e-02 4.21247123e-01
1.08843495e-01 6.126809312e-01 0.580117926e-01 0.07080918e-01 0.43939343e-01
Layer 4
-6.17867499e-01 -5.19734350e-01 3.27070479e-01
I Biases (for each layer)
Layer 0
None
Layer 1
7.74421338e-01 3.01849071e-01 -5.34393257e-01 2.58081297e-01 1.488884979e-01 4.32546372e-01 1.11683101e+00 -1.39061521e-01
-1.08843495e-01 9.39796305e-02 -1.53200605e-01 -6.44484932e-01 4.15796409e-02
Layer 3
-5.56346490e-01 -1.78546311e-02 1.587715264e-01
Layer 4
1.664335594e-01

```

BIBLIOGRAPHY

- Kerwin J.E. and Newman J.N., A Summary of the H.IRVING PRATT Ocean Race Handicapping Project *Proc. of 4th Chesapeake Sailing Yacht Symposium* ,pp 19-34, Annapolis, MD, 1979;
- Strohmeier D.D, The Measurement Handicapping System of USYRU *Proc. of 4th Chesapeake Sailing Yacht Symposium* ,pp 35-46, Annapolis, MD 1979;
- Hazen G., A Model of Sail Aerodynamics for Diverse Rig Types *Proc. New England Sailing Yacht Symposium* ,New London, CT, 1980;
- Gerritsma I.J., Keuning I.J. and Onnink A.R., The Delft Systematic Yacht Hull (Series II) Experiments, *Proc. of 11th Chesapeake Sailing Yacht Symposium*,Annapolis, MD, 1993;
- Ranzenbach R. and Teeters J., Aerodynamic Performance of Offwind Sails attached to Sprints, *Proc. of 15th Chesapeake Sailing Yacht Symposium*, Annapolis, MD, 2001;
- Teeters J., Ranzenbach R. and Prince M., Changes to Sail Aerodynamics in the IMS Rule, *Proc. of 16th Chesapeake Sailing Yacht Symposium*, Annapolis, MD, 2003;
- Teeters J., Pallard R. and Muselet Caroline, Analysis of Hull Shape Effects on Hydrodynamic Drag in Offshore Handicap Racing Rules, *Proc. of 16th Chesapeake Sailing Yacht Symposium*, Annapolis, MD, 2003;
- Fossati F., Claughton A., Battistin D., Muggiasca S., Changes and Development to Sail Aerodynamics in the ORC International Rule *Proc. of 20th HISWA Symposium*, Amsterdam, 2008;
- Poor C., The IMS, a description of the new international rating system, Washington DC, 1986;
- Claughton A., Developments in the IMS VPP formulations, *Proc. of 14th Chesapeake Sailing Yacht Symposium*, Annapolis, MD, 1999;
- Hoerner F., Fluid Dynamic Drag, *Hoerner Fluid Dynamics* , Bakersfield, CA, 1965;
- World Sailing, Equipment Rules of Sailing, , 2016;